

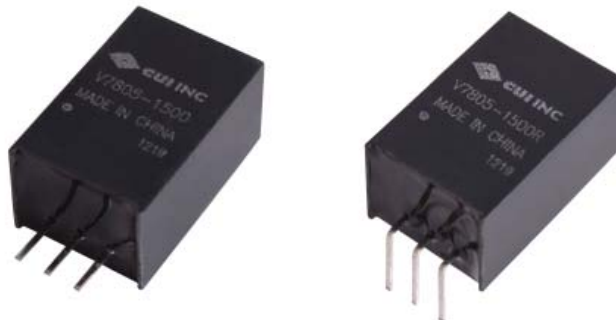

SERIES: V78-1500 | **DESCRIPTION:** NON-ISOLATED SWITCHING REGULATOR

FEATURES

- 1.5 A current output
- extremely high efficiency up to 97%
- no heat sink required
- pin compatible to LM78XX linear regulators
- available in straight and right angle SIP packages
- low ripple and noise
- short circuit protection, thermal shutdown
- wide temperature (-40~85°C)



| MODEL | input voltage | | output voltage | output current | ripple and noise ¹ | efficiency |
|-------------|---------------|-------------|----------------|----------------|-------------------------------|-------------|
| | typ (Vdc) | range (Vdc) | (Vdc) | max (mA) | max (mVp-p) | Vin max (%) |
| V7802-1500* | 12 | 4.75~18 | 2.5 | 1,500 | 45 | 85 |
| V7803-1500 | 12 | 4.75~18 | 3.3 | 1,500 | 45 | 88 |
| V7805-1500 | 12 | 6.5~18 | 5 | 1,500 | 45 | 91 |
| V7806-1500 | 12 | 8~18 | 6.5 | 1,500 | 45 | 93 |

Notes: 1. ripple and noise are measured at 20 MHz BW
 *. Discontinued

PART NUMBER KEY

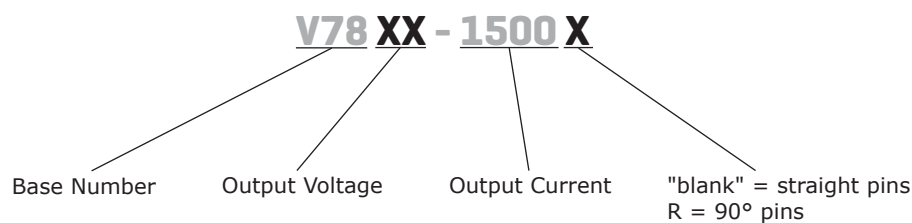

INPUT

| parameter | conditions/description | min | typ | max | units |
|-------------------------|------------------------|------|-----|-----|-------|
| operating input voltage | 2.5 and 3.3 V outputs | 4.75 | 12 | 18 | Vdc |
| | 5 V output | 6.5 | 12 | 18 | Vdc |
| | 6.5 V output | 8 | 12 | 18 | Vdc |

OUTPUT

| parameter | conditions/description | min | typ | max | units |
|-------------------------|-------------------------------------|-----|-------|-------|-------|
| line regulation | Vin = min ~ max, at full load | | ±0.5 | ±0.75 | % |
| load regulation | measured from 10% load to full load | | ±0.5 | ±1.0 | % |
| voltage accuracy | 100% load | | ±2 | ±3 | % |
| switching frequency | 100% load, input voltage range | 300 | 340 | 380 | kHz |
| temperature coefficient | | | ±0.02 | | %/°C |

PROTECTIONS

| parameter | conditions/description | min | typ | max | units |
|--------------------------|--------------------------------|-----|-----|-----|-------|
| short circuit protection | continuous, automatic recovery | | | | |
| thermal shutdown | | | 150 | | °C |

SAFETY AND COMPLIANCE

| parameter | conditions/description | min | typ | max | units |
|-----------|--|-----------|-----|-----|-------|
| EMI/EMC | EN 55022 class B, EN 61000-4-2 class A | | | | |
| MTBF | | 2,000,000 | | | hours |
| RoHS | 2011/65/EU | | | | |

ENVIRONMENTAL

| parameter | conditions/description | min | typ | max | units |
|-----------------------|---------------------------------|-----|-----|-----|-------|
| operating temperature | | -40 | | 85 | °C |
| storage temperature | | -55 | | 125 | °C |
| case temperature | | | | 100 | °C |
| storage humidity | non-condensing | | | 95 | % |
| temperature rise | at full load | | 25 | | °C |
| lead temperature | 1.5 mm from case for 10 seconds | | | 300 | °C |

DERATING CURVES

1. output power vs. ambient temperature

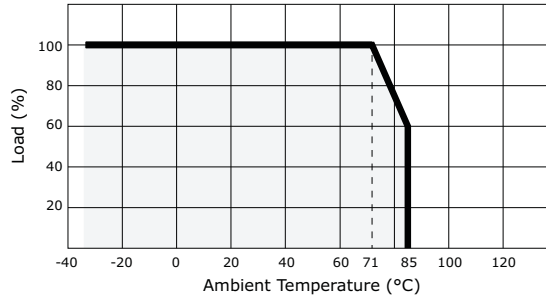

MECHANICAL

| parameter | conditions/description | min | typ | max | units |
|---------------|---|-----|-----|-----|-------|
| dimensions | 0.689 x 0.354 x 0.453 (11.50 x 9.00 x 17.50 mm) | | | | inch |
| case material | plastic (UL94-V0) | | | | |
| weight | | | 4.0 | | g |

MECHANICAL DRAWING

units: mm [inches]
 tolerance: ±0.25 [±0.010]
 pin section tolerance: ±0.10 mm [±0.004]

V78XX-1500

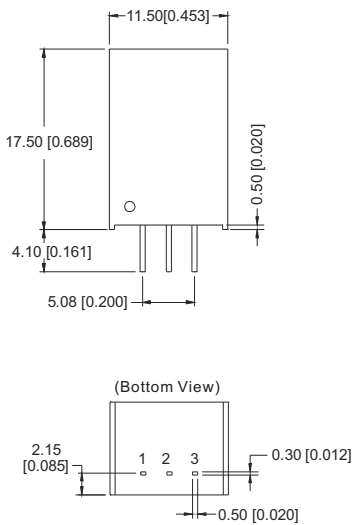

V78XX-1500R

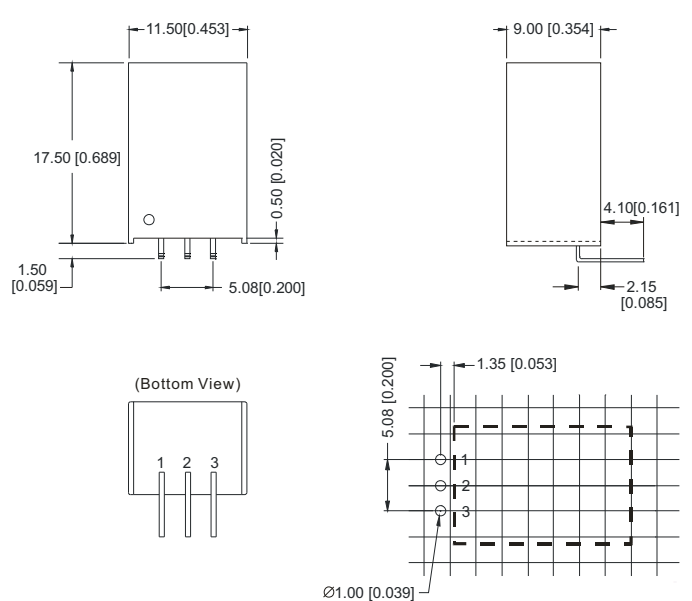

| PIN CONNECTIONS | |
|-----------------|----------|
| PIN | FUNCTION |
| 1 | +Vin |
| 2 | GND |
| 3 | +Vo |

EXTERNAL CAPACITOR TABLE

| Part Number | C1 (Ceramic capacitor) | C2 (Ceramic capacitor) |
|-------------|------------------------|------------------------|
| V7802-1500 | 10 μ F/25V | 22 μ F/6.3V |
| V7803-1500 | 10 μ F/25V | 22 μ F/6.3V |
| V7805-1500 | 10 μ F/25V | 22 μ F/16V |
| V7806-1500 | 10 μ F/25V | 22 μ F/16V |

TYPICAL APPLICATION CIRCUIT

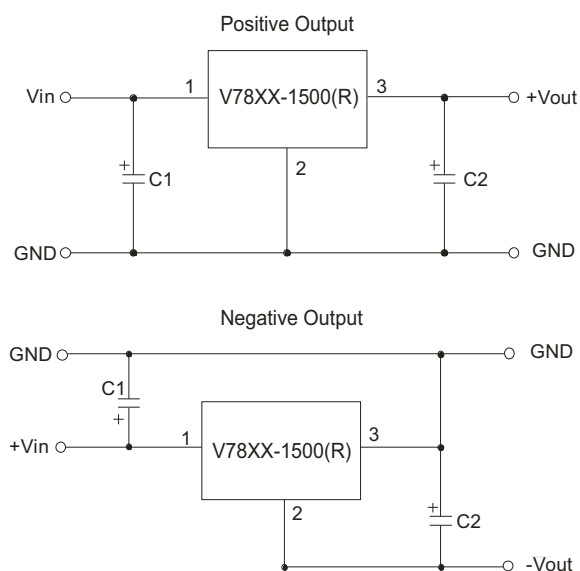

APPLICATION EXAMPLE

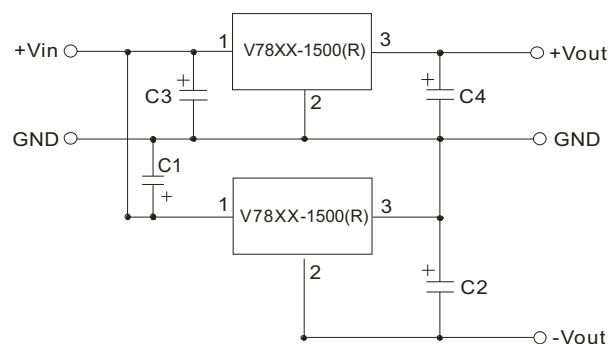

Note:

1. C1 and C2 are required and should be fitted close to the converter pins.
2. The capacitance of C1 and C2 sees external capacitor table, it can be increased properly if required, and tantalum or low ESR electrolytic capacitors may also suffice.
3. No parallel connection or plug and play.

INPUT FILTER CIRCUIT

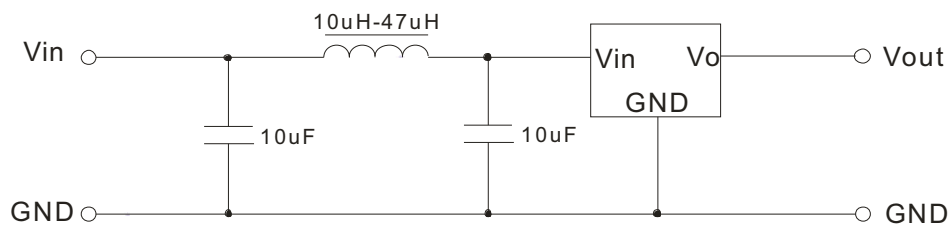

OUTPUT FILTER CIRCUIT

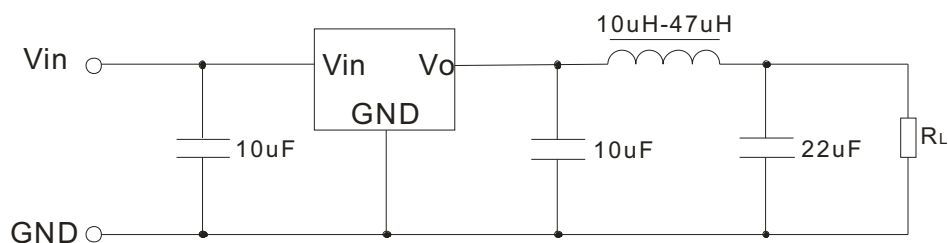

EMC RECOMMENDED CIRCUIT

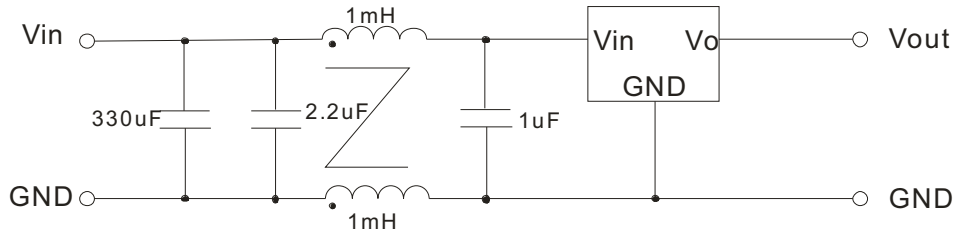

TEST CONFIGURATION

Efficiency and Output Voltage Ripple Test

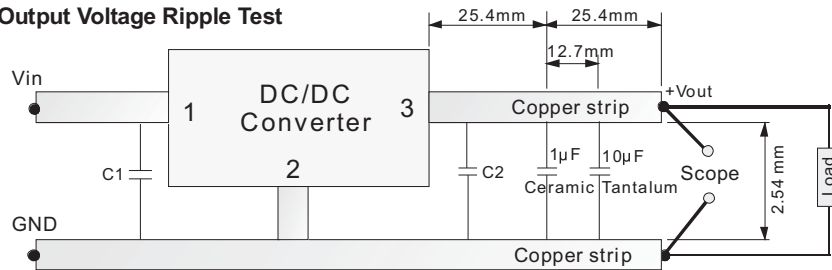

Start-up and Load Transient Response Test

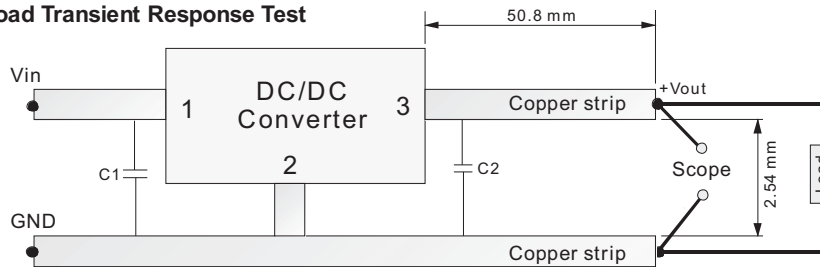

EFFICIENCY AND RIPPLE CURVES

Efficiency

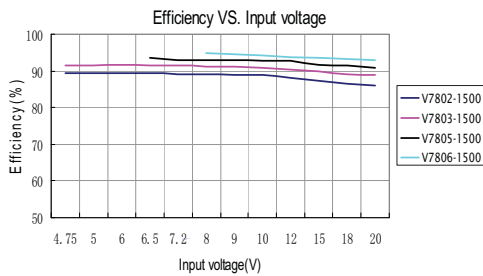

Ripple

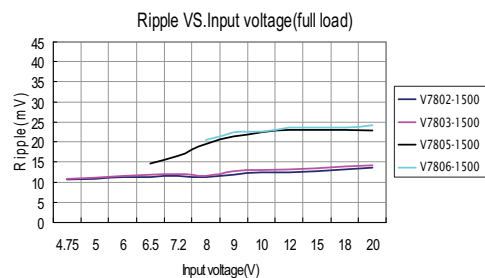
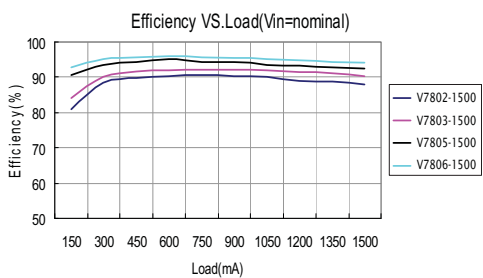
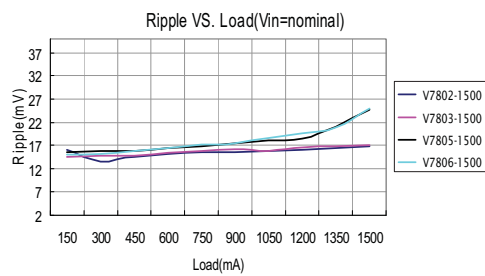

REVISION HISTORY

| rev. | description | date |
|------|--------------------------------------|------------|
| 1.0 | initial release | 07/16/2010 |
| 1.01 | V-Infinity branding removed | 09/04/2012 |
| 1.02 | updated typical application circuits | 09/25/2012 |
| 1.03 | discontinued model V7802-1500 | 03/21/2014 |

The revision history provided is for informational purposes only and is believed to be accurate.

**CUI INC[®]**

Headquarters
20050 SW 112th Ave.
Tualatin, OR 97062
800.275.4899

Fax 503.612.2383
cui.com
techsupport@cui.com

CUI offers a two (2) year limited warranty. Complete warranty information is listed on our website.

CUI reserves the right to make changes to the product at any time without notice. Information provided by CUI is believed to be accurate and reliable. However, no responsibility is assumed by CUI for its use, nor for any infringements of patents or other rights of third parties which may result from its use.

CUI products are not authorized or warranted for use as critical components in equipment that requires an extremely high level of reliability. A critical component is any component of a life support device or system whose failure to perform can be reasonably expected to cause the failure of the life support device or system, or to affect its safety or effectiveness.