

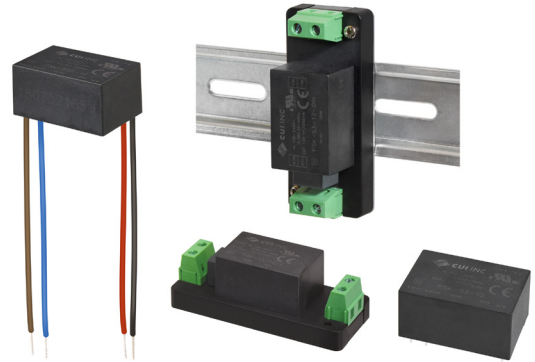

SERIES: PSK-S3 | **DESCRIPTION:** AC-DC POWER SUPPLY

FEATURES

- universal input range (85 ~ 264 Vac)
- wide operating temperature range (-40 to +70 °C)
- 4K Vac minimum isolation voltage
- over-current, over-voltage, and short-circuit protection
- low-profile encapsulated package (18 mm / 0.709")
- 85 mm (3.346") lead configuration available with "-L" suffix
- chassis-mount configuration available with "-T" suffix
- DIN-rail configuration available with "-DIN" suffix



| MODEL | output voltage (Vdc) | output current | | output power max (W) | ripple and noise ¹ max (mVp-p) | efficiency ² typ (%) |
|-----------|-------------------------|----------------|-------------|----------------------------|---|---------------------------------------|
| | | min (mA) | max (mA) | | | |
| PSK-S3-3 | 3.3 | 0 | 700 | 2.3 | 100 | 66 |
| PSK-S3-5 | 5 | 0 | 600 | 3 | 100 | 74 |
| PSK-S3-9 | 9 | 0 | 330 | 3 | 100 | 75 |
| PSK-S3-12 | 12 | 0 | 250 | 3 | 100 | 77 |
| PSK-S3-15 | 15 | 0 | 200 | 3 | 100 | 77 |
| PSK-S3-24 | 24 | 0 | 125 | 3 | 100 | 78 |

Notes: 1. At full load, nominal input, 20 MHz bandwidth oscilloscope, with 1 µF ceramic and 10 µF electrolytic capacitors on the output.
 2. At 230 Vac input.
 3. All specifications are measured at Ta=25°C, humidity <75%, nominal input voltage, and rated output load unless otherwise specified.

PART NUMBER KEY

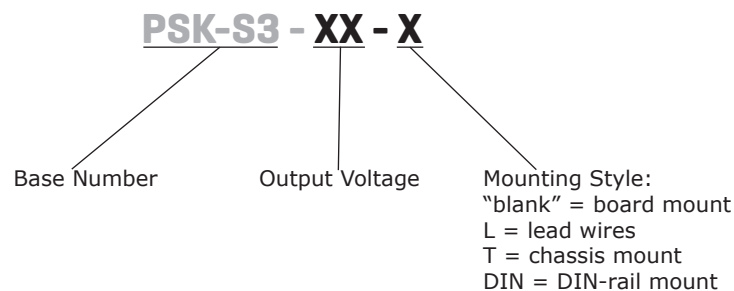

INPUT

| parameter | conditions/description | min | typ | max | units |
|-----------------|------------------------|-----|-----|-----|-------|
| voltage | | 85 | | 264 | Vac |
| | | 100 | | 370 | Vdc |
| frequency | | 47 | | 63 | Hz |
| current | at 115 Vac | | | 80 | mA |
| | at 230 Vac | | | 45 | mA |
| inrush current | at 115 Vac | | 10 | | A |
| | at 230 Vac | | 20 | | A |
| leakage current | at 230 Vac, 50 Hz | | 0.1 | | mA |

OUTPUT

| parameter | conditions/description | min | typ | max | units |
|----------------------------|-------------------------|-----|-------|------|-------|
| capacitive load | 3, 5 Vdc output models | | | 6000 | μF |
| | 9, 12 Vdc output models | | | 1500 | μF |
| | 15 Vdc output models | | | 1000 | μF |
| | 24 Vdc output models | | | 330 | μF |
| initial set point accuracy | 3.3 Vdc output models | | ±3 | | % |
| | all other models | | ±2 | | % |
| line regulation | at full load | | ±0.5 | | % |
| load regulation | from 0~100% load | | ±1 | | % |
| hold-up time | at 115 Vac | | 10 | | ms |
| | at 230 Vac | | 60 | | ms |
| switching frequency | | | 100 | | kHz |
| temperature coefficient | | | ±0.02 | | %/°C |

PROTECTIONS

| parameter | conditions/description | min | typ | max | units |
|--------------------------|---------------------------|-----|-----|-----|-------|
| over voltage protection | 3, 5 Vdc output models | | | 7.5 | Vdc |
| | 9 Vdc output models | | | 15 | Vdc |
| | 12, 15 Vdc output models | | | 20 | Vdc |
| | 24 Vdc output models | | | 30 | Vdc |
| over current protection | auto recovery | | | 150 | % |
| short circuit protection | continuous, auto recovery | | | | |

SAFETY & COMPLIANCE

| parameter | conditions/description | min | typ | max | units |
|---------------------|--|-------|-----|-----|-------|
| isolation voltage | input to output for 1 minute | 4,000 | | | Vac |
| safety approvals | UL 62368-1, EN 62368-1, IEC 62368-1 | | | | |
| safety class | Class II | | | | |
| conducted emissions | CISPR32/EN55032, Class A | | | | |
| | CISPR32/EN55032, Class B (external circuit required, see Figure 2) | | | | |
| radiated emissions | CISPR32/EN55032, Class A | | | | |
| | CISPR32/EN55032, Class B (external circuit required, see Figure 2) | | | | |
| ESD | IEC/EN61000-4-2, contact ±6 kV/ air ±8kV, Class B | | | | |
| radiated immunity | IEC/EN61000-4-3, 10V/m, Class A | | | | |

SAFETY & COMPLIANCE (CONTINUED)

| parameter | conditions/description | min | typ | max | units |
|------------------------------|---|---------|-----|-----|-------|
| EFT/burst | IEC/EN61000-4-4, ± 2 kV, Class B (external circuit required, see Figure 1) | | | | |
| | IEC/EN61000-4-4, ± 4 kV, Class B (external circuit required, see Figure 2) | | | | |
| surge | IEC/EN61000-4-5, line to line ± 1 kV, Class B (external circuit required, see Figure 1) | | | | |
| | IEC/EN61000-4-5, line to line ± 2 kV/line to ground ± 4 kV, Class B (external circuit required, see Figure 2) | | | | |
| conducted immunity | IEC/EN61000-4-6, 10 Vrms, Class A | | | | |
| voltage dips & interruptions | IEC/EN61000-4-11 Class B, 0%-70% | | | | |
| MTBF | as per MIL-HDBK-217F at 25°C | 300,000 | | | hours |
| RoHS | yes | | | | |

Notes: 4. The power supply is considered a component which will be installed into final equipment. The final equipment still must be tested to meet the necessary EMC directives.

ENVIRONMENTAL

| parameter | conditions/description | min | typ | max | units |
|-----------------------|------------------------|-----|-----|-----|-------|
| operating temperature | see derating curves | -40 | | 70 | °C |
| storage temperature | | -40 | | 105 | °C |
| storage humidity | non-condensing | | | 95 | % |

SOLDERABILITY⁵

| parameter | conditions/description | min | typ | max | units |
|----------------|------------------------|-----|-----|-----|-------|
| hand soldering | for 3~5 seconds | 350 | 360 | 370 | °C |
| wave soldering | for 5~10 seconds | 255 | 260 | 265 | °C |

Notes: 5. For board mount models only



DERATING CURVES

Load vs. Ambient Temperature
(at 85~264 Vac / 100~370 Vdc Input Voltage)

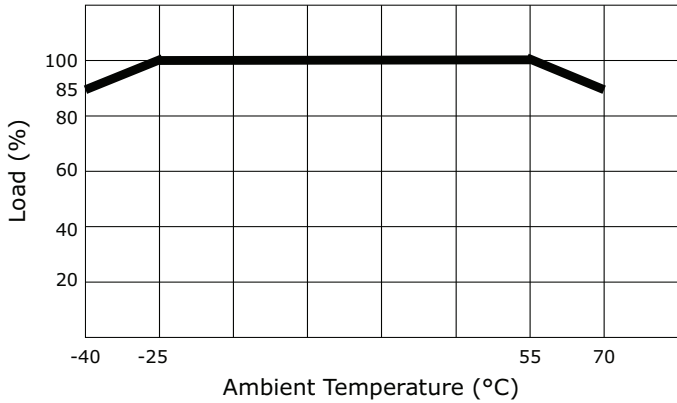

Load vs. Input Voltage
(at 25°C Ambient Temperature)

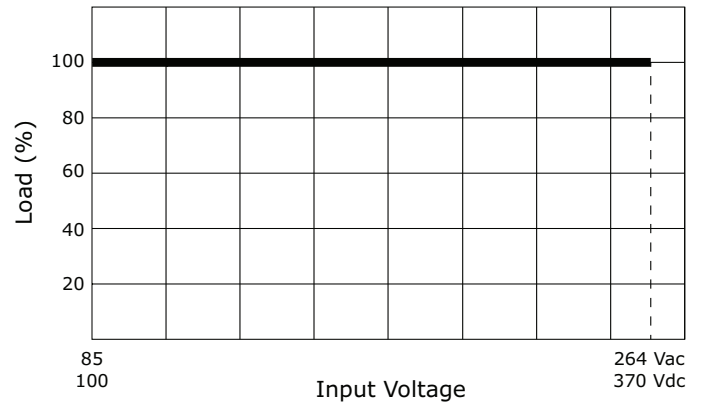

EFFICIENCY CURVES

Efficiency vs. Input Voltage
(at full load)

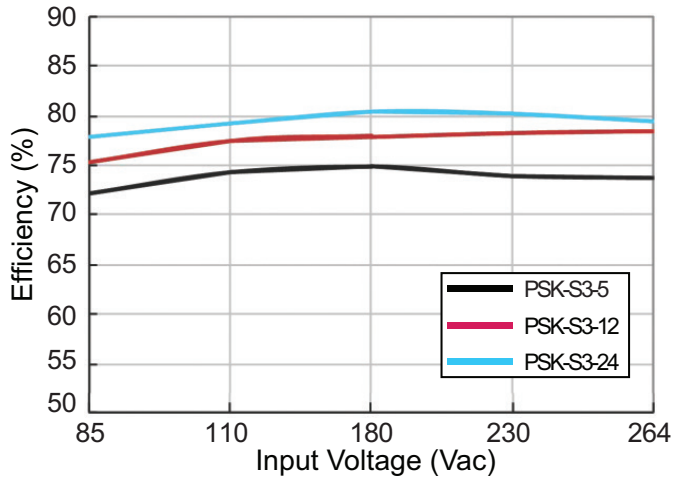

Efficiency vs. Load Current
(at 230 Vac)

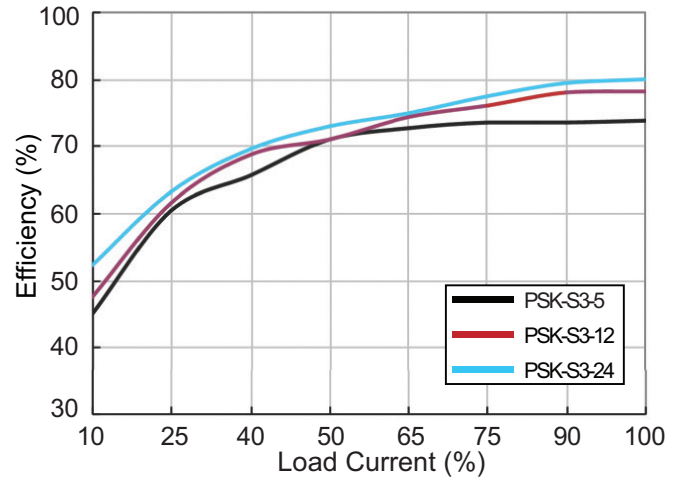

MECHANICAL

| parameter | conditions/description | min | typ | max | units |
|---------------|---|-----|-----|-----|-------|
| dimensions | board mount: 37.00 x 24.50 x 18.00 (1.457 x 0.965 x 0.709 inch) | | | | mm |
| | lead wires: 37.00 x 24.50 x 18.00 (1.457 x 0.965 x 0.709 inch) | | | | mm |
| | chassis mount: 76.00 x 31.50 x 26.80 (2.992 x 1.24 x 1.055 inch) | | | | mm |
| | DIN-Rail mount: 76.00 x 31.50 x 31.40 (2.992 x 1.24 x 1.236 inch) | | | | mm |
| case material | black flame-retardant and heat-resistant plastic (UL94V-0) | | | | |
| weight | board mount | | 25 | | g |
| | lead wires | | 25 | | g |
| | chassis mount | | 47 | | g |
| | DIN-Rail mount | | 69 | | g |

MECHANICAL DRAWING (BOARD MOUNT)

units: mm[inch]

tolerance: $\pm 0.50[\pm 0.020]$

pin diameter tolerance: $\pm 0.10[\pm 0.004]$

| PIN CONNECTIONS | |
|-----------------|----------|
| PIN | Function |
| 1 | AC (L) |
| 3 | AC (N) |
| 13 | NC |
| 14 | -Vo |
| 16 | +Vo |

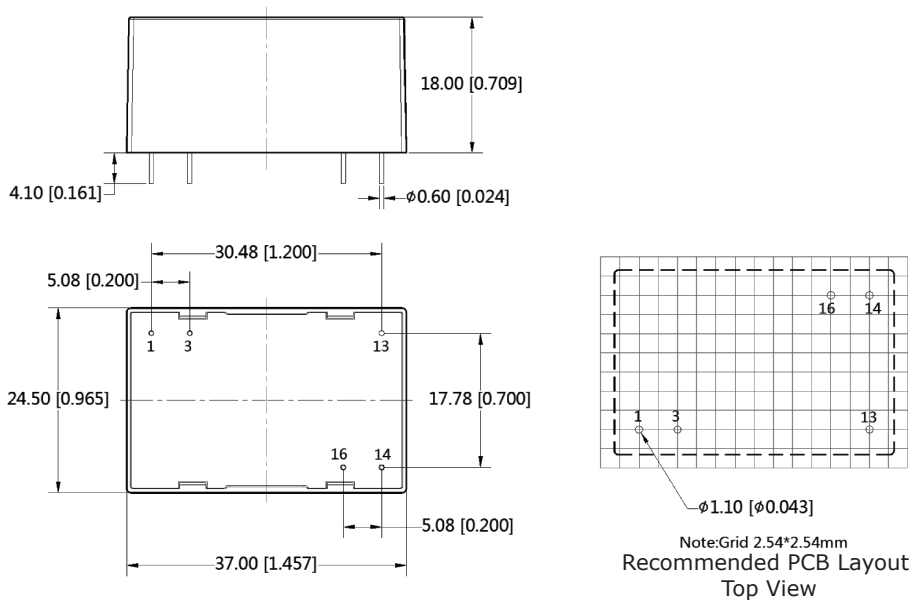

MECHANICAL DRAWING (LEAD WIRES)

units: mm [inch]

tolerance: $\pm 0.50[\pm 0.020]$

wire diameter tolerance: $\pm 0.30[\pm 0.012]$

| WIRE CONNECTIONS | | | |
|------------------|-------|----------------|----------|
| PIN | COLOR | WIRE TYPE | Function |
| 1 | brown | UL-1015 22 AWG | AC (L) |
| 3 | blue | UL-1015 22 AWG | AC (N) |
| 14 | black | UL-1430 22 AWG | -Vo |
| 16 | red | UL-1430 22 AWG | +Vo |

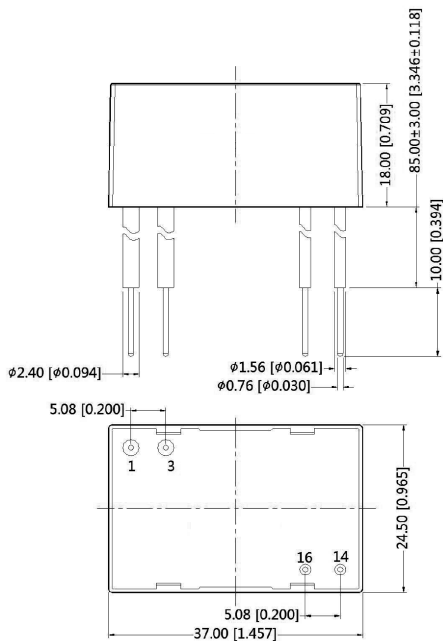

MECHANICAL DRAWING (CHASSIS MOUNT)

units: mm[inch]
tolerance: $\pm 0.50[\pm 0.020]$

wire range: 24~12 AWG
tightening torque: max 0.4 N*m

| PIN CONNECTIONS | |
|-----------------|----------|
| PIN | Function |
| 1 | AC (N) |
| 2 | AC (L) |
| 3 | -Vo |
| 4 | +Vo |



MECHANICAL DRAWING (DIN-RAIL MOUNT)

units: mm [inch]
tolerance: $\pm 1.00[\pm 0.039]$

installed on DIN Rail TS35
wire range: 24~12 AWG
tightening torque: max 0.4 N*m

| PIN CONNECTIONS | |
|-----------------|----------|
| PIN | Function |
| 1 | AC (N) |
| 2 | AC (L) |
| 3 | -Vo |
| 4 | +Vo |

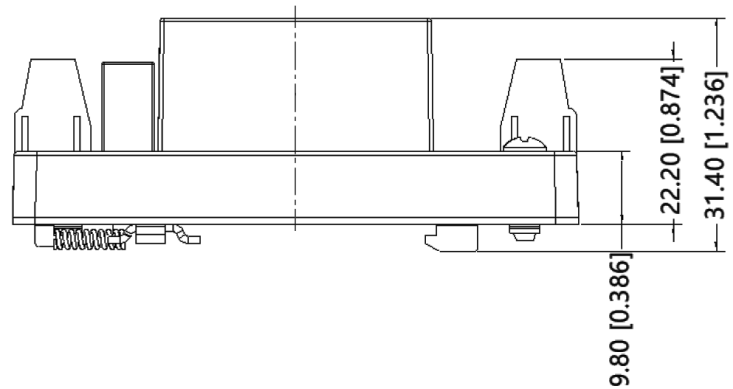

APPLICATION CIRCUIT

Figure 1



Table 1

| Recommended External Circuit Components | | | | | |
|---|-------------------|------------------|-----------|-------------|----------|
| Vo (Vdc) | FUSE ⁶ | MOV ⁶ | C1 | C2 | TVS |
| 3.3 | 1A/250V | S14K350 | 1 μ F | 150 μ F | SMBJ7.0A |
| 5 | 1A/250V | S14K350 | 1 μ F | 150 μ F | SMBJ7.0A |
| 9 | 1A/250V | S14K350 | 1 μ F | 120 μ F | SMBJ12A |
| 12 | 1A/250V | S14K350 | 1 μ F | 120 μ F | SMBJ20A |
| 15 | 1A/250V | S14K350 | 1 μ F | 120 μ F | SMBJ20A |
| 24 | 1A/250V | S14K350 | 1 μ F | 68 μ F | SMBJ30A |

Notes: 6. Chassis Mount and DIN-Rail Mount versions include the fuse and MOV components.

EMC RECOMMENDED CIRCUIT

Figure 2

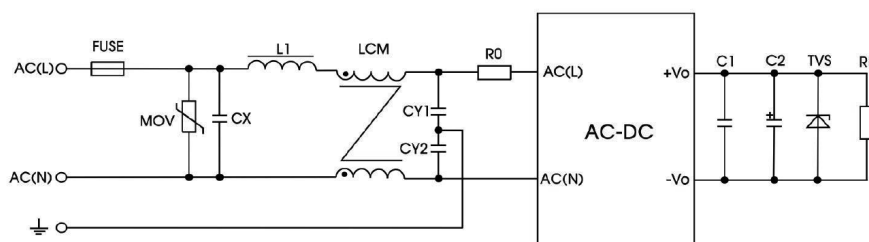

Table 2

| Recommended External Circuit Components | |
|---|------------------------|
| FUSE | 2 A/250 V, slow fusing |
| MOV | S14K350 |
| LCM | 10~30 mH |
| CX | 0.1 μ F/275 Vac |
| L1 | 330 μ H/ 2 A |
| CY1/CY2 | 1 nF/400 Vac |
| R0 | 33 Ω /3 W |

Note: Also refer to Table 1.

Notes: 7. C1 is a ceramic capacitor used to filter high frequency noise.
 8. C2 is an electrolytic capacitor and it is recommended to be high frequency and low impedance. For capacitance and current of capacitor, refer to the datasheet provided by the manufacturer. Voltage derating of capacitor should be at least 80%.
 9. TVS is a recommended component to protect post-circuits (if converter fails).

REVISION HISTORY

| rev. | description | date |
|------|-----------------|------------|
| 1.0 | initial release | 11/12/2018 |

The revision history provided is for informational purposes only and is believed to be accurate.



Headquarters
20050 SW 112th Ave.
Tualatin, OR 97062
800.275.4899

Fax 503.612.2383
cui.com
techsupport@cui.com

CUI offers a two (2) year limited warranty. Complete warranty information is listed on our website.

CUI reserves the right to make changes to the product at any time without notice. Information provided by CUI is believed to be accurate and reliable. However, no responsibility is assumed by CUI for its use, nor for any infringements of patents or other rights of third parties which may result from its use.

CUI products are not authorized or warranted for use as critical components in equipment that requires an extremely high level of reliability. A critical component is any component of a life support device or system whose failure to perform can be reasonably expected to cause the failure of the life support device or system, or to affect its safety or effectiveness.