

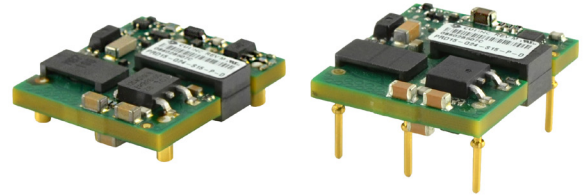

SERIES: PRD15 | **DESCRIPTION:** DC-DC CONVERTER

FEATURES

- up to 15 W isolated output
- industry standard 1" x 1" package
- 4:1 input range
- low ripple & noise
- over voltage, over current, short circuit, and over temperature protections
- remote on/off control
- output trim
- -40 to 85°C temperature range
- efficiency up to 89%
- UL/cUL safety approval



MODEL	input voltage		output voltage	output current		output power	ripple & noise ¹	efficiency
	typ (Vdc)	range (Vdc)	(Vdc)	min (A)	max (A)	max (W)	max (mVp-p)	typ (%)
PRD15-Q24-S3	24	9~36	3.3	0.45	4.5	14.85	90	89
PRD15-Q24-S5	24	9~36	5	0.3	3	15	125	87.3
PRD15-Q24-S12	24	9~36	12	0.13	1.3	15.6	150	84.5
PRD15-Q24-S15	24	9~36	15	0.11	1.1	16.5	175	85
PRD15-Q48-S3	48	18~75	3.3	0.5	5	16.5	90	88
PRD15-Q48-S5	48	18~75	5	0.3	3	15	95	86
PRD15-Q48-S12	48	18~75	12	0.13	1.3	15.6	120	85
PRD15-Q48-S15	48	18~75	15	0.11	1.1	16.5	120	85.3

Notes: 1. At full load, nominal input, 20 MHz bandwidth oscilloscope, input terminated with a 100 µF capacitor for 24 Vdc input models and a 4.7 µF capacitor for 48 Vdc input models. Output terminated with 1 µF and 10 µF low ESR capacitors.
 2. All specifications are measured at Ta=25°C, nominal input voltage, and rated output load unless otherwise specified. All models are tested and specified with a 100 µF capacitor for 24 Vdc input models and a 4.7 µF capacitor for 48 Vdc input models on the input, and with 1 µF and 10 µF low ESR capacitors on the output.

PART NUMBER KEY

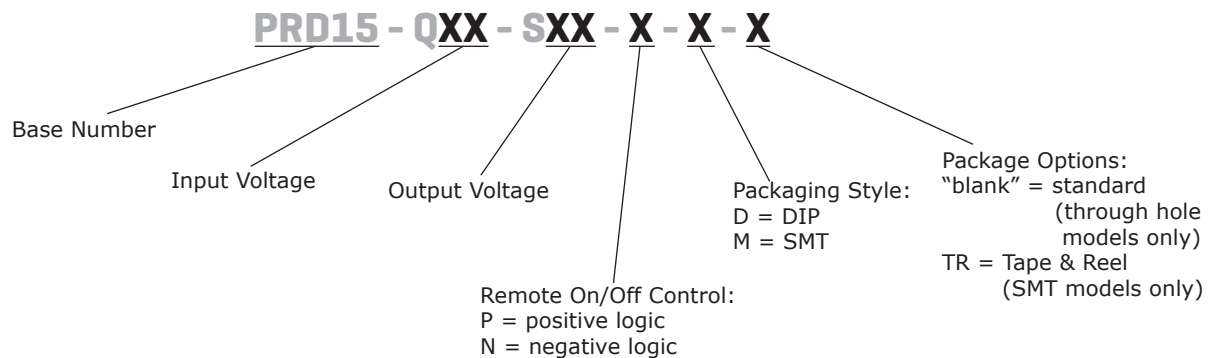

INPUT

parameter	conditions/description	min	typ	max	units
operating input voltage	24 Vdc input models	9	24	36	Vdc
	48 Vdc input models	18	48	75	Vdc
current	24 Vdc input models			2.1	A
	48 Vdc input models			1.1	A
start-up voltage	24 Vdc input models	8.8			Vdc
	48 Vdc input models		16.7		Vdc
under voltage shutdown	PRD15-Q24-S3		8.6		Vdc
	PRD15-Q24-S5		8.5		Vdc
	PRD15-Q24-S12, PRD15-Q24-S15		8.4		Vdc
	PRD15-Q48-S15		16.2		Vdc
	all other models		15.6		Vdc
remote on/off ¹	positive logic	models ON (10~15 Vdc or open circuit)			
		models OFF (-0.7~0.7 Vdc)			
	negative logic	models ON (-0.7~0.8 Vdc)			
		models OFF (10~15 Vdc or open circuit)			
filter	PRD15-Q48-S5: inductance filter all other models: capacitance filter				
input reverse polarity protection	no				
input fuse	recommended to add fuse: 4 A fast blow fuse for 24 Vdc input models 2 A fast blow fuse for 48 Vdc input models 1.5 A fast blow fuse for PRD15-Q48-S12 model				

Notes: 1. On/Off current is 1 mA.

OUTPUT

parameter	conditions/description	min	typ	max	units
maximum capacitive load	low ESR <0.02 Ω			1,000	μF
	PRD15-Q24-S3, S5, S12 & PRD15-Q48-S3 all other models			470	μF
line regulation	PRD15-Q48-S3			±0.2	%
	PRD15-Q48-S12			±0.075	%
	all other models			±0.05	%
load regulation	PRD15-Q24-S3			±0.1	%
	PRD15-Q24-S5			±0.075	%
	PRD15-Q48-S3			±0.2	%
	PRD15-Q48-S5			±0.06	%
	all other models			±0.05	%
voltage accuracy	at 50% load		±1		%
start-up time				50	ms
adjustability ²	see application notes		±10		%
switching frequency	PRD15-Q24-S12, PRD15-Q24-S15		340		kHz
	PRD15-Q48-S5		375		kHz
	PRD15-Q48-S15		380		kHz
	all other models		350		kHz
dynamic load response	50-75-50% load change to 1% Vout		150		μs
	PRD15-Q24-S3, PRD15-Q24-S12 all other models		100		μs
temperature coefficient			±0.02		%/°C

Note: 2. For input voltage < 20 Vdc, PRD15-Q48-S5 can only be trimmed down.

PROTECTIONS

parameter	conditions/description	min	typ	max	units
over voltage protection	auto restart				
	PRD15-Q24-S3		4.5		Vdc
	PRD15-Q24-S5		5.9		Vdc
	PRD15-Q24-S12		14.1		Vdc
	PRD15-Q24-S15		19.5		Vdc
	PRD15-Q48-S3		3.9		Vdc
	PRD15-Q48-S5		5.9		Vdc
	PRD15-Q48-S12		15		Vdc
over current protection	PRD15-Q48-S15		20		Vdc
	current limiting, auto restart				
	PRD15-Q24-S3		6.0		A
	PRD15-Q24-S5		4.6		A
	PRD15-Q24-S12		2.0		A
	PRD15-Q24-S15		1.6		A
	PRD15-Q48-S3		7.2		A
	PRD15-Q48-S5		4.5		A
short circuit protection	PRD15-Q48-S12		1.8		A
	PRD15-Q48-S15		1.7		A
short circuit protection	current limiting, hiccup auto restart		0.3		A
over temperature protection	PRD15-Q48-S12		135		°C
	all other models		115		°C

SAFETY AND COMPLIANCE

parameter	conditions/description	min	typ	max	units
isolation voltage	input to output, basic insulation				
	24 Vdc input models		2,000		Vdc
	48 Vdc input models		2,250		Vdc
isolation resistance		10			MΩ
isolation capacitance	PRD15-Q24-S5, PRD15-Q24-S15, PRD15-Q48-S3		1,500		pF
	all other models		1,000		pF
safety approvals	UL 60950-1, 2nd Edition				
LVD ¹	2006/95/EC (CE mark)				
MTBF	as per Telcordia SR-332 Method 1, Case 3, ground fixed conditions, Tpcboard = 25 °C, full load, natural air convection.	2,000,000			hours
RoHS	2011/65/EU				

Note: 1. CE mark only on 48 Vdc input models.

ENVIRONMENTAL

parameter	conditions/description	min	typ	max	units
operating temperature	see derating curves	-40		85	°C
storage temperature		-55		125	°C

SOLDERABILITY

parameter	conditions/description	min	typ	max	units
wave soldering	for Sn/Ag/Cu based solders (for through hole models):				
	preheat temperature			115	°C
	solder pot temperature			270	°C
	solder dwell time			7	s
reflow soldering	reflow solder profile below is suitable for SAC305 type lead-free solders (for surface mount models)		245	260	°C

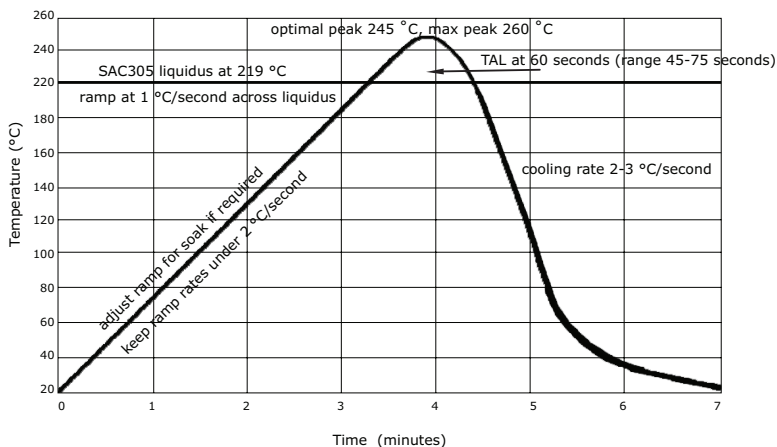

MECHANICAL

parameter	conditions/description	min	typ	max	units
dimensions	through hole: 1.10 x 0.96 x 0.33 [27.9 x 24.4 x 8.4 mm]				inches
	surface mount: 1.10 x 0.96 x 0.33 [27.9 x 24.4 x 8.4 mm]				inches
weight	through hole mount models		10		g
	surface mount models		10.2		g

MECHANICAL DRAWING (THROUGH HOLE)

units: inches [mm]
 tolerance: X.XX ±0.02 [0.5]
 X.XXX ±0.010 [0.25]

PIN CONNECTIONS	
PIN	Function
1	+Vin
2	-Vin
3	+Vout
4	output trim
5	-Vout
6	on/off control

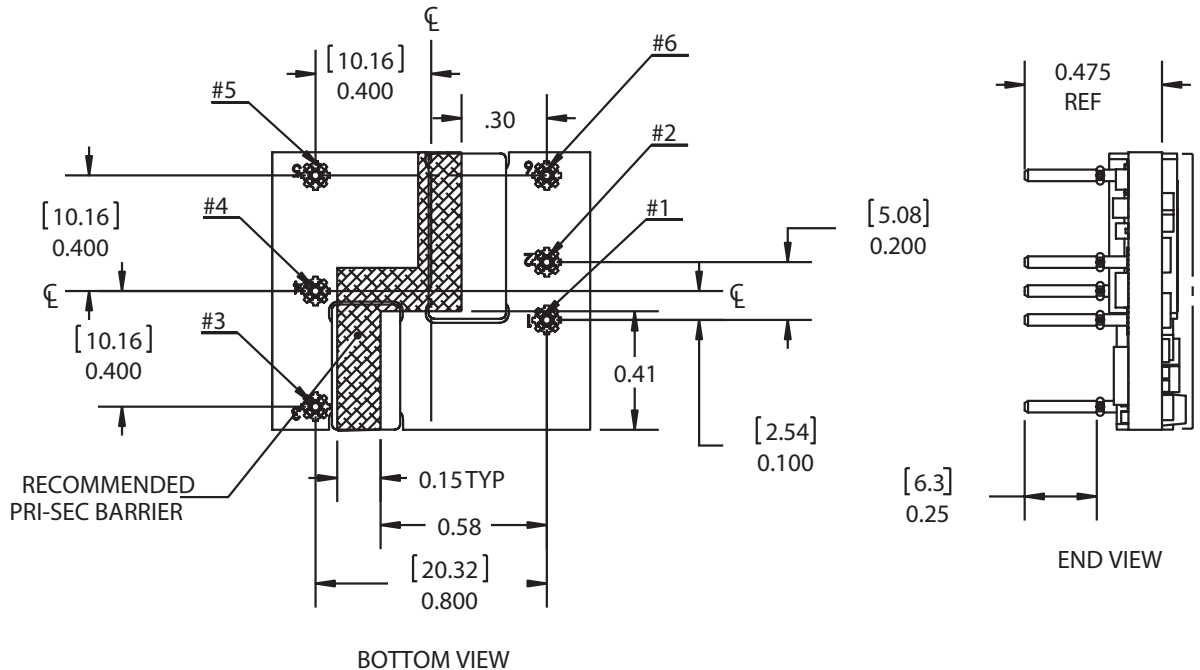
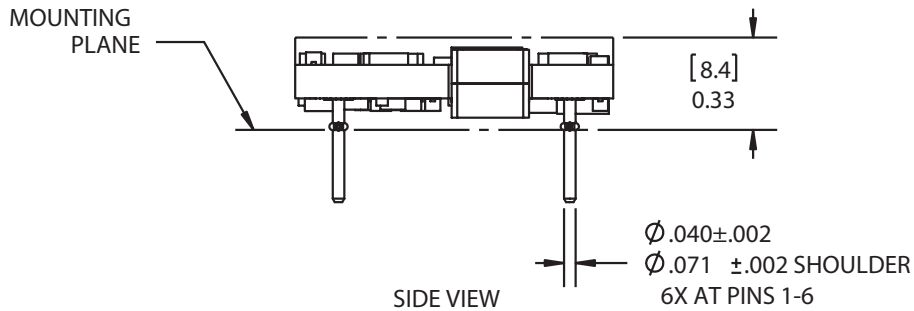
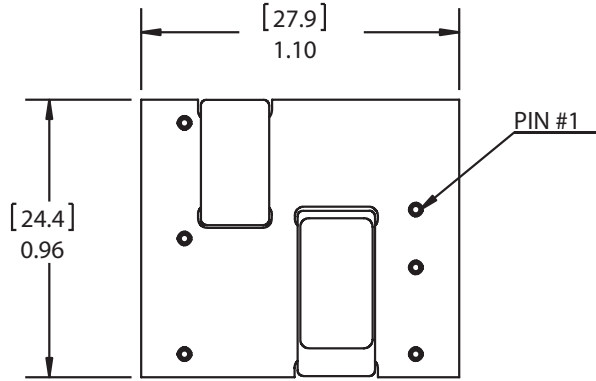

MECHANICAL DRAWING (SURFACE MOUNT)

units: inches [mm]
 tolerance: X.XX ±0.02 [0.5]
 X.XXX ±0.010 [0.25]

PIN CONNECTIONS	
PIN	Function
1	+Vin
2	-Vin
3	+Vout
4	output trim
5	-Vout
6	on/off control

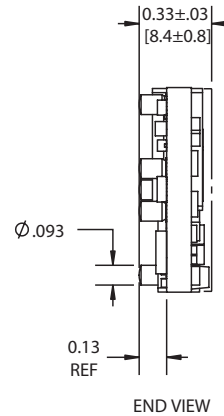
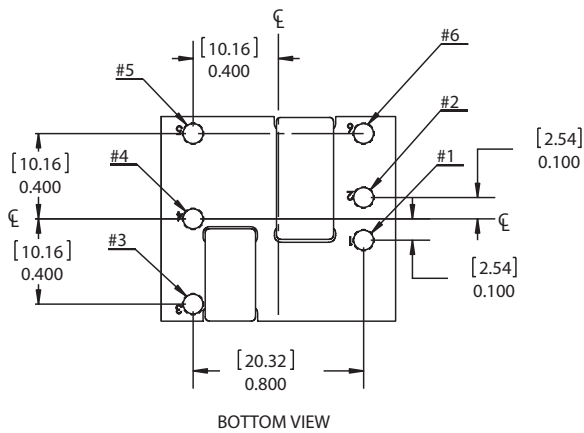
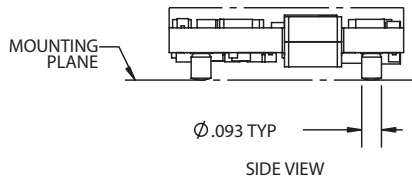
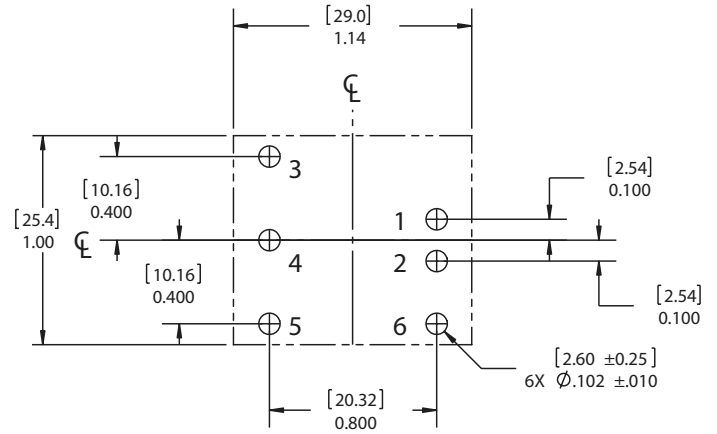
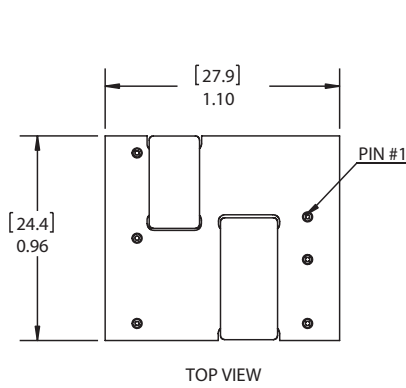

DERATING CURVES

PRD15-Q48-S3 Derating Curves @ Sea Level
(Vin=24, airflow from input to output)

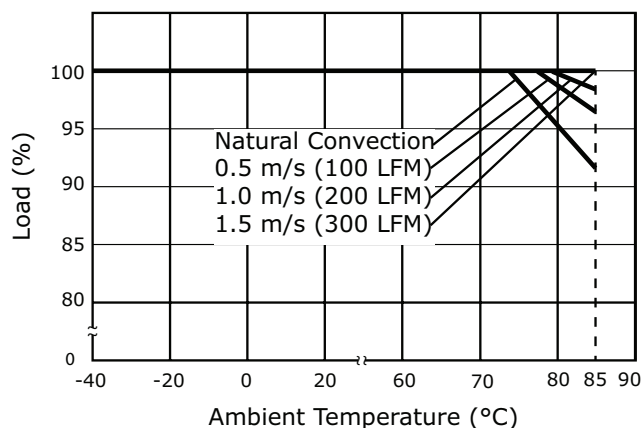

PRD15-Q48-S3 Derating Curves @ Sea Level
(Vin=48, airflow from input to output)

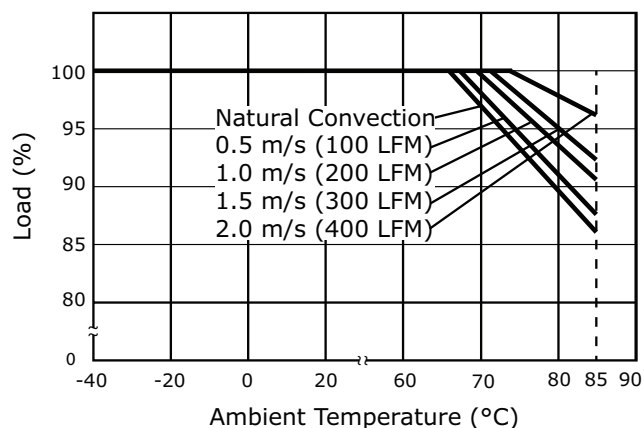

All other models, Derating Curves @ Sea Level
(See conditions in Table 1)

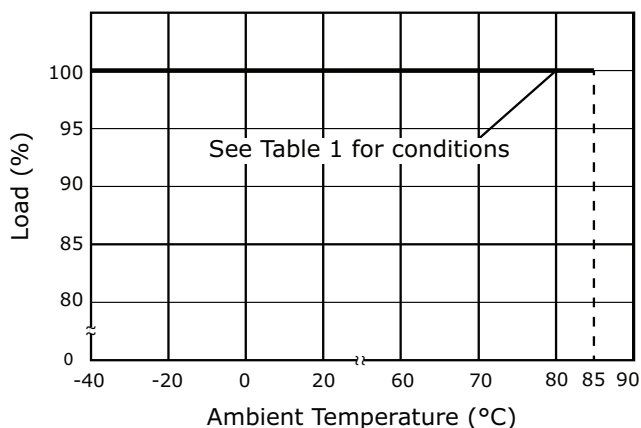
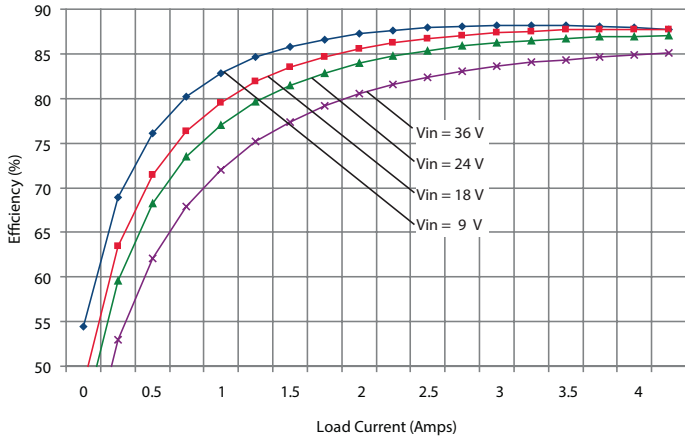

Table 1

Model	Input (Vdc)	Direction of airflow	Airflow
PRD15-Q24-S3	12/24	Input to output	Natural Convection
PRD15-Q24-S5	24	Input to output	0.33 m/s (65 LFM)
PRD15-Q24-S12	24	Input to output	0.33 m/s (65 LFM)
PRD15-Q24-S15	12/24	Input to output	Natural Convection
PRD15-Q48-S5	24/48	Input to output	Natural Convection
PRD15-Q48-S12	24/48	Pin 2 to Pin 1	Natural Convection
PRD15-Q48-S15	24/48	Input to output	Natural Convection

EFFICIENCY CURVES

PRD15-Q24-S3 Efficiency Curve
(Efficiency vs. Line Voltage and Load Current @ 25°C)



PRD15-Q48-S3 Efficiency Curve
(Efficiency vs. Line Voltage and Load Current @ 25°C)

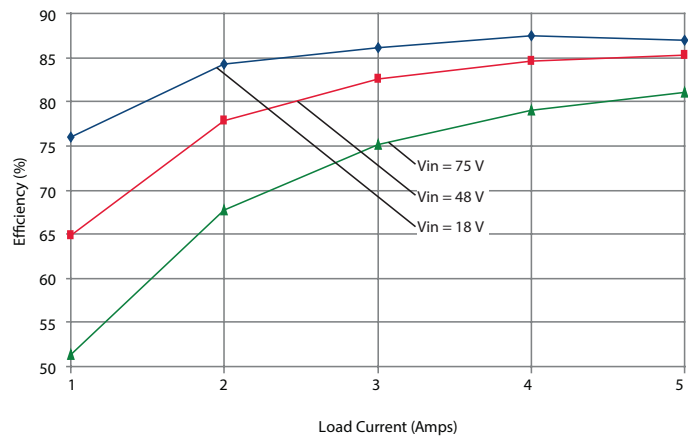

PRD15-Q24-S5 Efficiency Curve
(Efficiency vs. Line Voltage and Load Current @ 25°C)

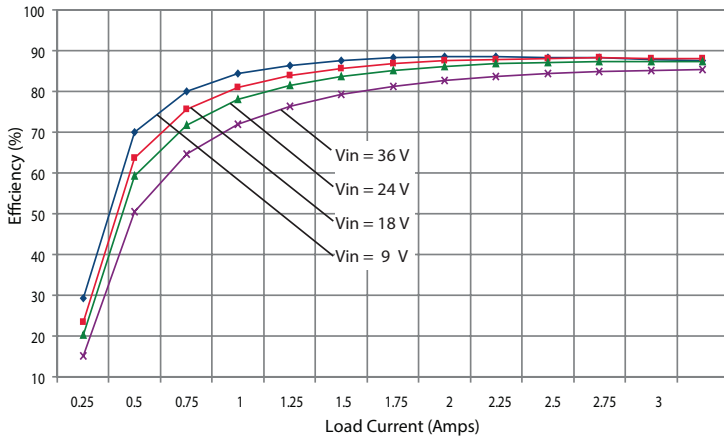

PRD15-Q48-S5 Efficiency Curve
(Efficiency vs. Line Voltage and Load Current @ 25°C)

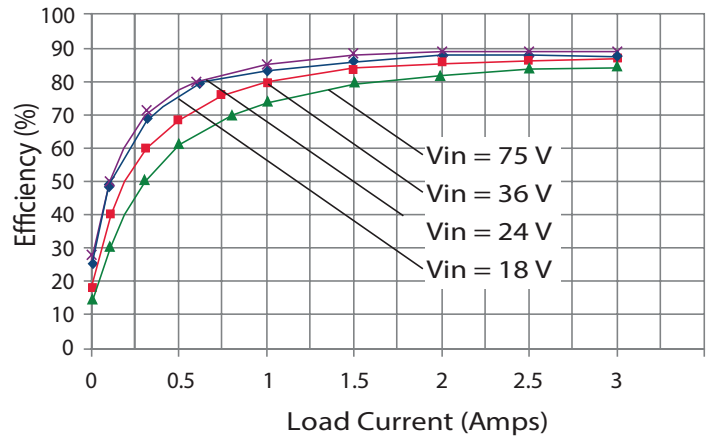

EFFICIENCY CURVES (CONTINUED)

PRD15-Q24-S12 Efficiency Curve
(Efficiency vs. Line Voltage and Load Current @ 25°C)

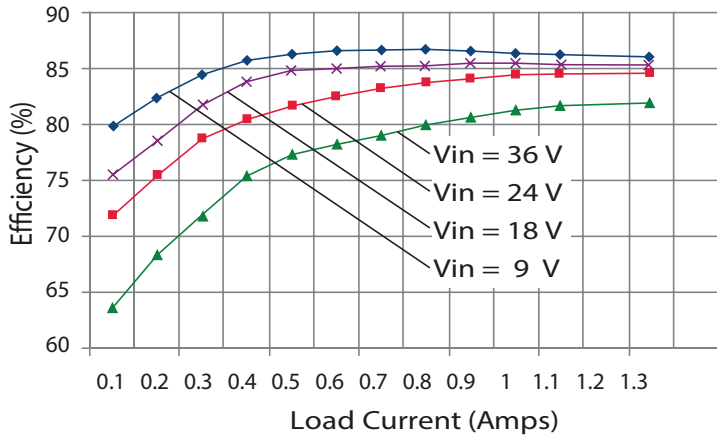

PRD15-Q48-S12 Efficiency Curve
(Efficiency vs. Line Voltage and Load Current @ 25°C)

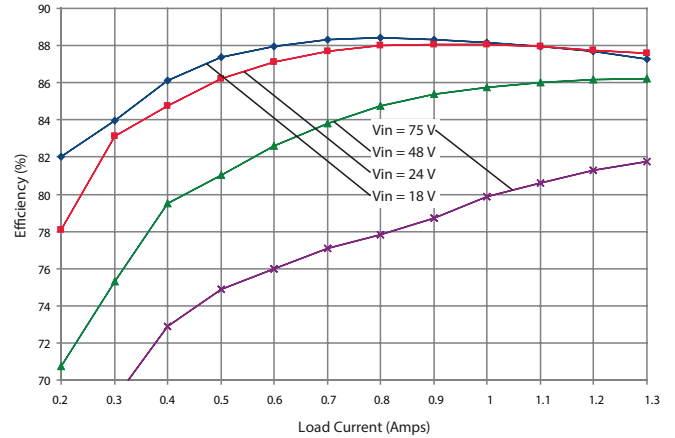

PRD15-Q24-S15 Efficiency Curve
(Efficiency vs. Line Voltage and Load Current @ 25°C)

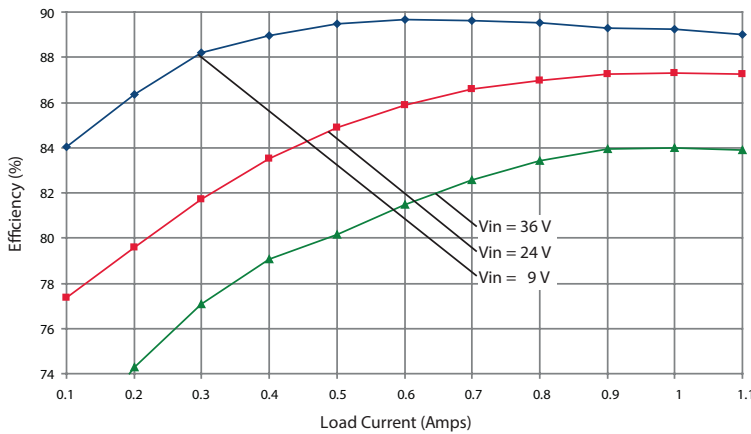

PRD15-Q48-S15 Efficiency Curve
(Efficiency vs. Line Voltage and Load Current @ 25°C)

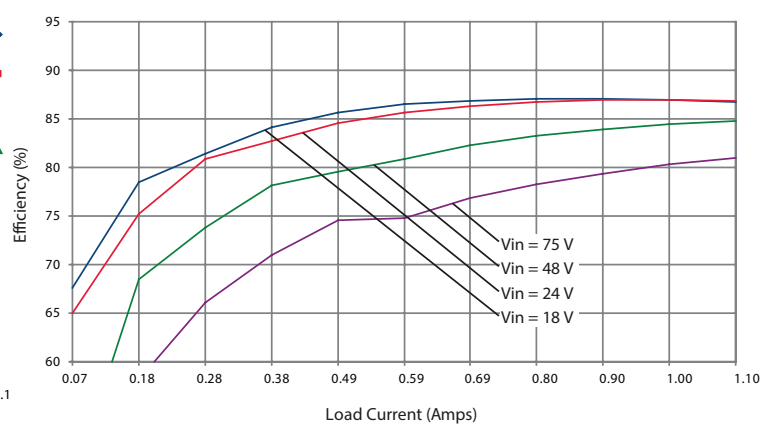

PACKAGING (THROUGH HOLE)

units: mm [inches]
 tolerance: +1/-0 mm

Tray Material: Dow 220 anti-static ethafoam
 Tray Size: 252 x 252 x 19.1 mm
 QTY: 30 pcs per tray (6 x 5)

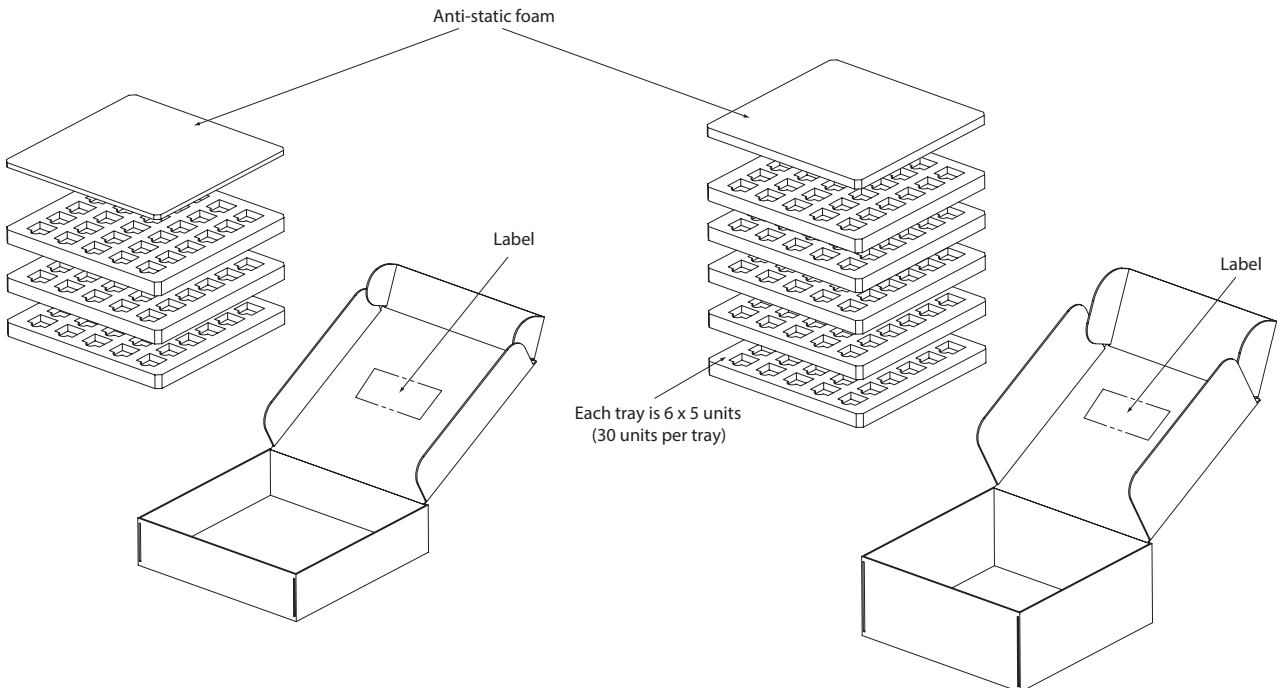
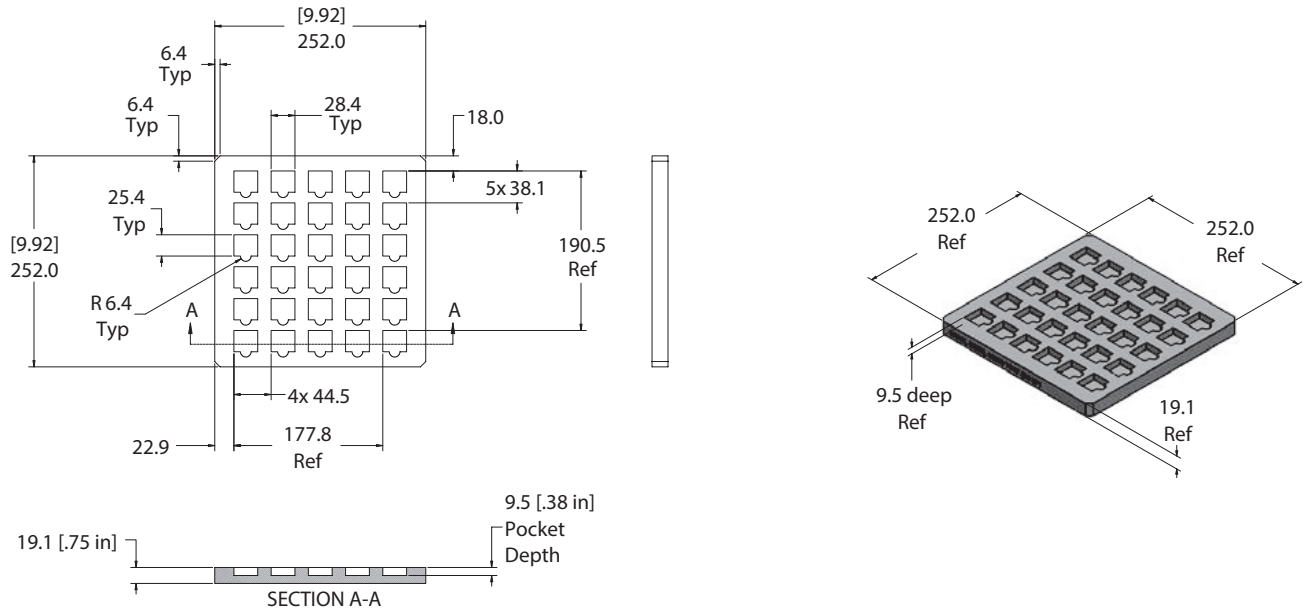

PACKAGING (SURFACE MOUNT)

units: inches [mm]

Tape & Reel: Conforms to EIA-481

Reel Size: Ø13"

QTY: 100 pcs per reel

Note: The SMT package has an MSL 2 rating

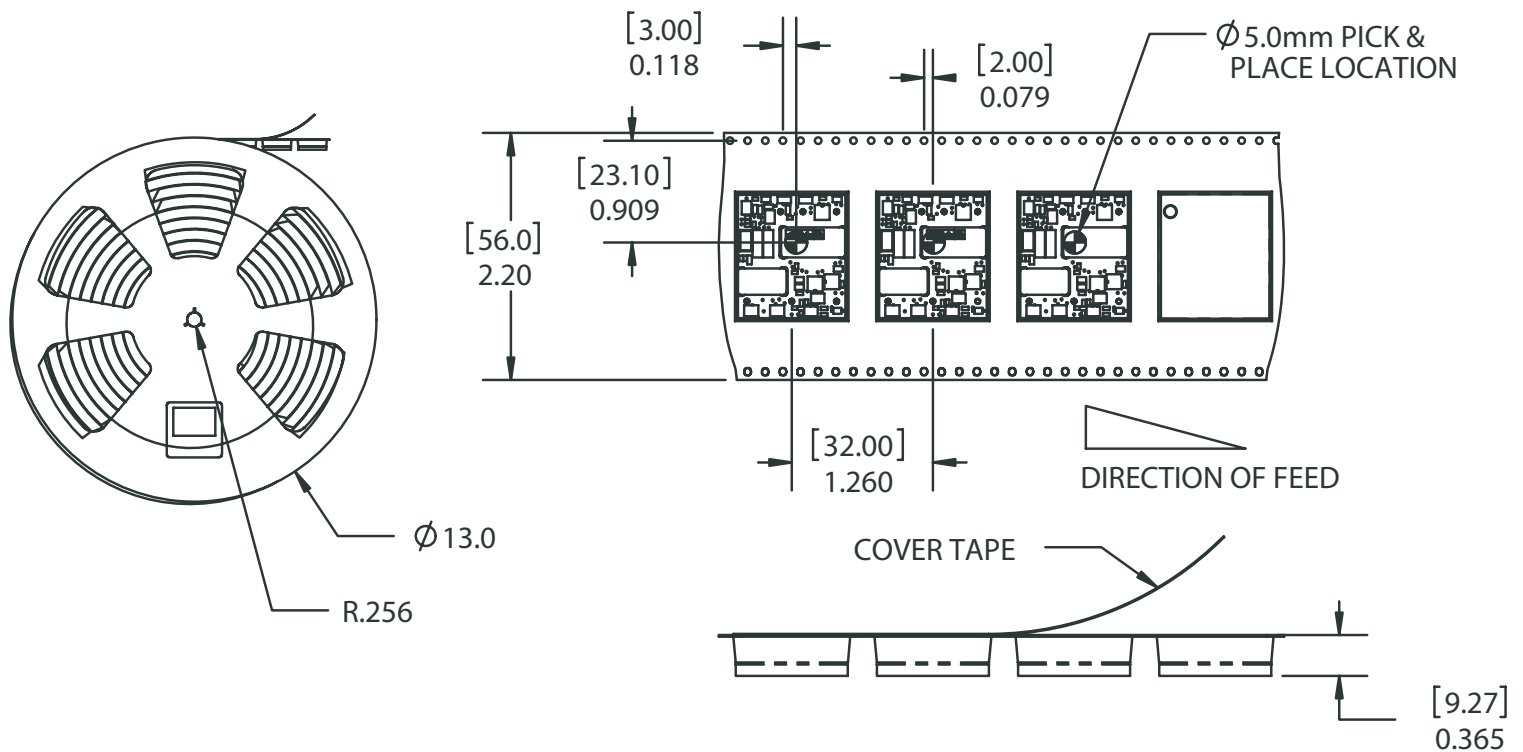

TEST CONFIGURATIONS

Input Ripple Current & Output Noise

All models are tested and specified for input reflected ripple current and output noise as per layouts shown in Figures 1 & 2. The Cbus and Lbus components simulate a typical DC voltage bus. However, your specific system configuration may require additional considerations.

Figure 1 Measuring Input Ripple Current

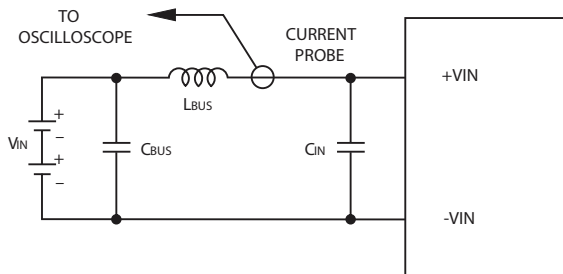

Table 1

C_{IN}	33 μ F, ESR < 700m Ω @ 100kHz
C_{BUS}	220 μ F, ESR < 100m Ω @ 100kHz
L_{BUS}	12 μ H

Figure 2 Measuring Output Ripple and noise (PARD)

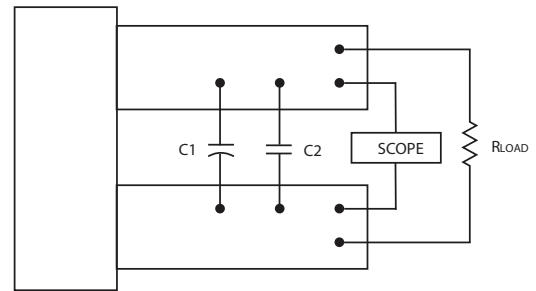

Table 2

C1	1 μ F
C2	10 μ F
load 2-3 inches (51-76mm) from module	

APPLICATION NOTES

Output Voltage Trimming

The output voltage can be adjusted by using the trim pin and the use of either an external trimpot or the use of a single fixed resistor (See Figures 3~5 below). Trimming resistors should have a low temperature coefficient (± 100 ppm/ $^{\circ}$ C or less) and be mounted close to the converter. For input voltage < 20 Vdc, PRD15-Q48-S5 can only be trimmed down. If the trim function is not needed, leave the trim pin open.

Figure 3 Trim Adjustments Using A Trimpot

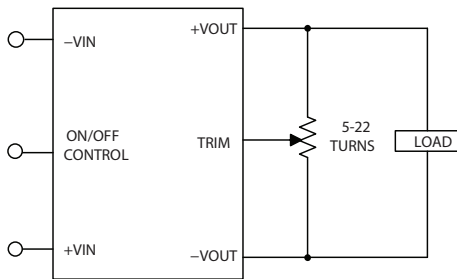

Figure 4 Trim Adjustments To Decrease Output Voltage Using A Fixed Resistor

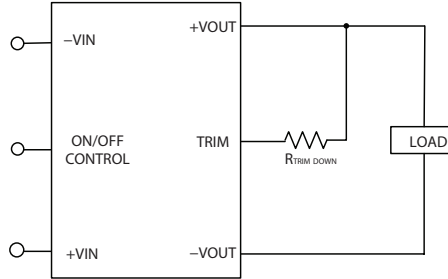
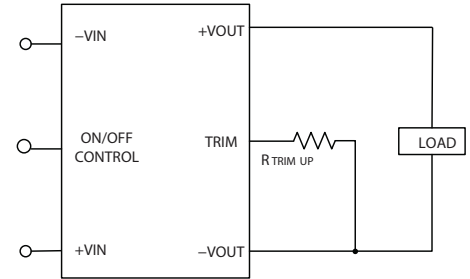

Figure 5 Trim Adjustments To Increase Output Voltage Using A Fixed Resistor



$$R_{trim - up} = \frac{A}{V_o - V_{o, nom}} - B$$

$$R_{trim - down} = \frac{C(V_o - 2.5)}{V_{o, nom} - V_o} - B$$

Note: $R_{trim-up}$ is the external resistor in Ω
 $R_{trim-down}$ is the external resistor in Ω
 $V_{o, nom}$ is the nominal output voltage
 V_o is the desired output voltage

Vout	A	B	C
3.3	12775	2050	5110
5	12775	2050	5110
12	25000	5110	10000
15	25000	5110	10000

Remote On/Off Control

The DC-DC converter can be ordered with either positive or negative logic. See page 2 for enable/disable details for both positive and negative logic options. Dynamic control of the On/Off function should be able to sink appropriate signal current when brought low and withstand appropriate voltage when brought high. Be aware that there is a finite time in milliseconds between the the time of On/Off control activation and stable, regulated output. This time will vary slightly with output load type and current and input conditions.

Cautions when using the On/Off control:

1. To retain full output circuit isolation, control the On/Off from the input side only.
2. While it is possible to control the On/Off with external logic if you carefully observe the voltage levels, the preferred circuit is either an open drain/open collector transistor, a switch, or a relay.
3. Do not apply voltages to the On/Off pin when there is no input power voltage, otherwise the converter may be permanently damaged.

Figure 6. Driving The On/Off Control Pin (Suggested Circuit)

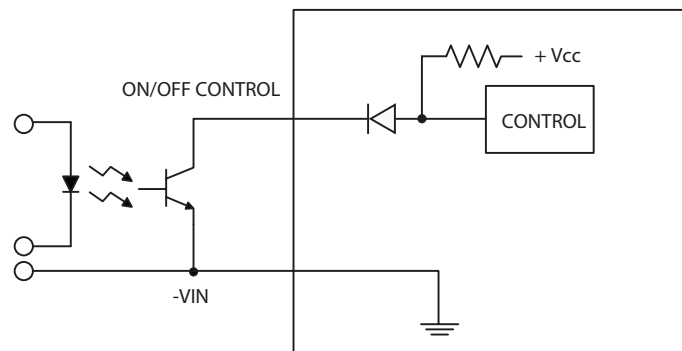

REVISION HISTORY

rev.	description	date
1.0	initial release	03/28/2016

The revision history provided is for informational purposes only and is believed to be accurate.



CUI INC[®]

Headquarters
20050 SW 112th Ave.
Tualatin, OR 97062
800.275.4899

Fax 503.612.2383
cui.com
techsupport@cui.com

CUI offers a two (2) year limited warranty. Complete warranty information is listed on our website.

CUI reserves the right to make changes to the product at any time without notice. Information provided by CUI is believed to be accurate and reliable. However, no responsibility is assumed by CUI for its use, nor for any infringements of patents or other rights of third parties which may result from its use.

CUI products are not authorized or warranted for use as critical components in equipment that requires an extremely high level of reliability. A critical component is any component of a life support device or system whose failure to perform can be reasonably expected to cause the failure of the life support device or system, or to affect its safety or effectiveness.