



**SERIES:** AE5-EW | **DESCRIPTION:** DC-DC CONVERTER

**FEATURES**

- 5 watts
- high operating temp -40 to +70°C
- 4,000 Vac isolation
- extra wide input voltage 10:1
- input voltage up to 1 kVdc
- OVP protection
- output short circuit protection
- board mounted
- EN 62109 approved



**MODEL**

MODEL	input voltage	output voltage	output current		output power	ripple & noise <sup>1</sup>	efficiency <sup>2</sup>
	range (Vdc)	(Vdc)	min (A)	max (A)	max (W)	max (mVp-p)	typ (%)
AE5-EW-S5	100~1000	5	0	1.0	5	200	72

Notes: 1. Measured at nominal input, 20 MHz bandwidth oscilloscope, with 10 µF electrolytic and 1 µF ceramic capacitors on the output.  
 2. Measured at 200 Vdc input voltage, full load.  
 3. All specifications are measured at Ta=25°C, humidity < 75%, nominal input voltage, and rated output load unless otherwise specified.

**PART NUMBER KEY**



## INPUT

parameter	conditions/description	min	typ	max	units
operating input voltage		100		1000	Vdc
current	at 200 Vdc at 600 Vdc at 1000 Vdc			38 15 10	mA mA mA
inrush current	at 200 Vdc at 600 Vdc at 1000 Vdc		7 20 30		A A A
input fuse	1 A / 1000 Vdc (external)				

## OUTPUT

parameter	conditions/description	min	typ	max	units
maximum capacitive load				6,000	μF
voltage accuracy			±1	±2	%
line regulation	from low line to high line, full load		±0.5	±1	%
load regulation	from 0% to full load		±0.5	±1	%
delay time	from Vin = 0 V to 90% of rated output voltage			1	s
switching frequency				75	kHz
temperature coefficient	at full load		±0.02		%/°C

## PROTECTIONS

parameter	conditions/description	min	typ	max	units
over voltage protection				7.5	Vdc
over current protection	automatic recovery	110			%
short circuit protection	continuous, automatic recovery				

## SAFETY AND COMPLIANCE

parameter	conditions/description	min	typ	max	units
isolation voltage	input to output for 1 minute	4,000			Vac
safety approvals	EN 62109				
conducted emissions	CISPR22/EN55022, class A (external circuit required, see Figure 2)				
radiated emissions	CISPR22/EN55022, class A (external circuit required, see Figure 2)				
ESD	IEC/EN61000-4-2, contact ± 6kV/air ± 8kV, class B				
radiated immunity	IEC/EN61000-4-3, 10V/m, class A				
EFT/burst	IEC/EN61000-4-4, ± 4kV, class B (external circuit required, see Figure 2)				
surge	IEC/EN61000-4-5, ± 2kV, class B (external circuit required, see Figure 2)				
conducted immunity	IEC/EN61000-4-6, 10 Vr.m.s, class A				
MTBF	as per MIL-HDBK-217F, 25°C	300,000			hours
RoHS	2011/65/EU				

## ENVIRONMENTAL

parameter	conditions/description	min	typ	max	units
operating temperature	see derating curves	-40		70	°C
storage temperature		-40		105	°C
storage humidity	non-condensing			95	%
altitude				2000	m

## SOLDERABILITY

parameter	conditions/description	min	typ	max	units
hand soldering	for 3~5 seconds	350	360	370	°C
wave soldering	for 5~10 seconds	255	260	265	°C

## MECHANICAL

parameter	conditions/description	min	typ	max	units
dimensions	70.00 x 48.00 x 23.50 [2.756 x 1.890 x 0.925 inch]				mm
case material	black flame-retardant heat-proof plastic (UL94V-0)				
weight			95		g

## MECHANICAL DRAWING

units: mm [inch]  
 tolerance: ±0.50[±0.020]  
 pin diameter tolerance: ±0.10[±0.004]

PIN CONNECTIONS	
PIN	Function
1	NC
2	-Vin
3	+Vin
4	+Vout
5	-Vout

NC=no connection

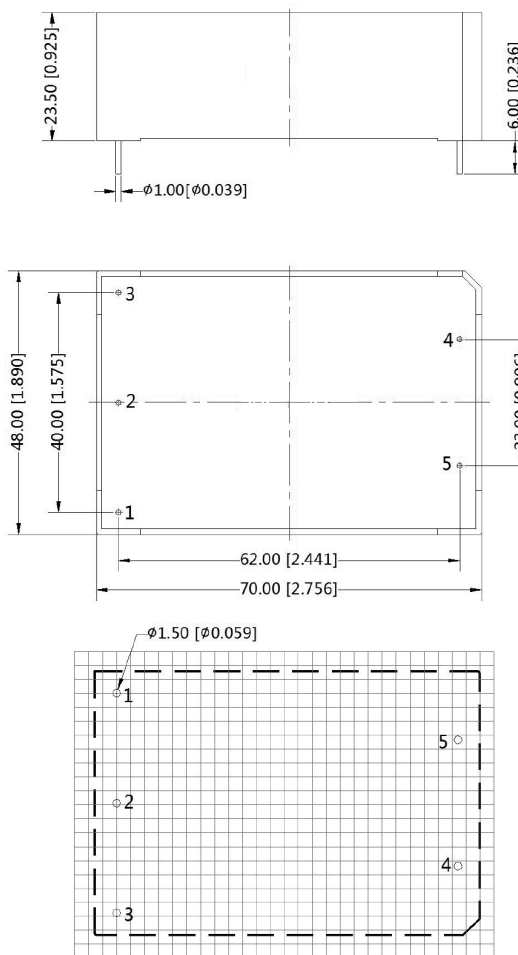

Note: Grid 2.54\*2.54mm  
 Recommended PCB Layout  
 Top View

## DERATING CURVES

Temperature Derating Curve  
(100~150 Vdc input voltage)

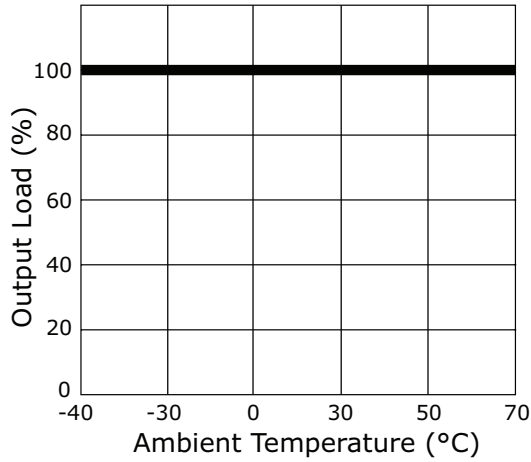

Temperature Derating Curve  
(150~1000 Vdc input voltage)

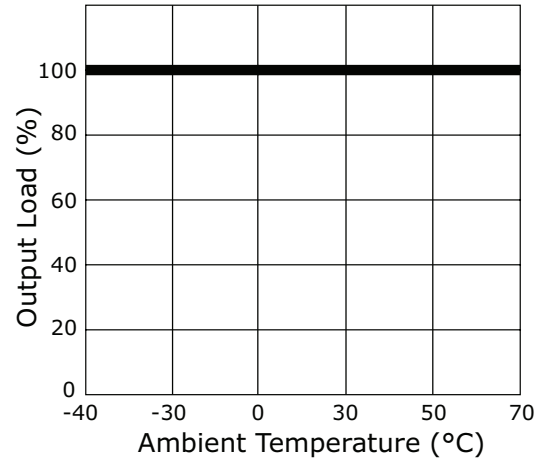

Load vs. Input Voltage Derating Curve  
(at 25°C)

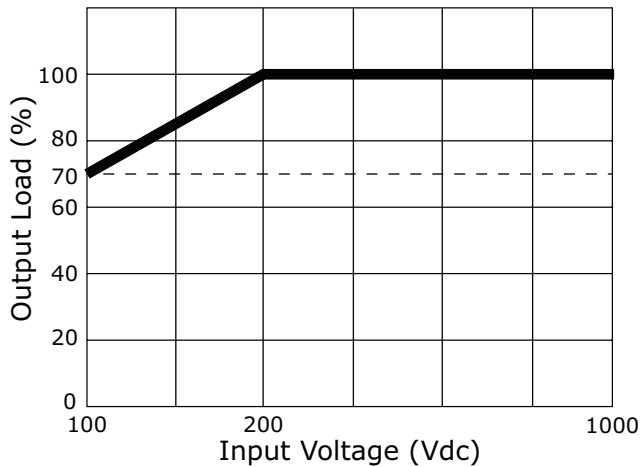

## EFFICIENCY CURVES

Efficiency Curve  
Efficiency vs. Input Voltage

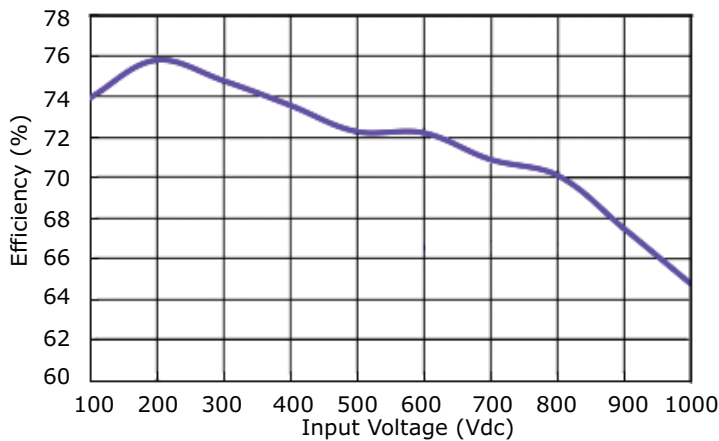

Efficiency Curve  
Efficiency vs. Load Current

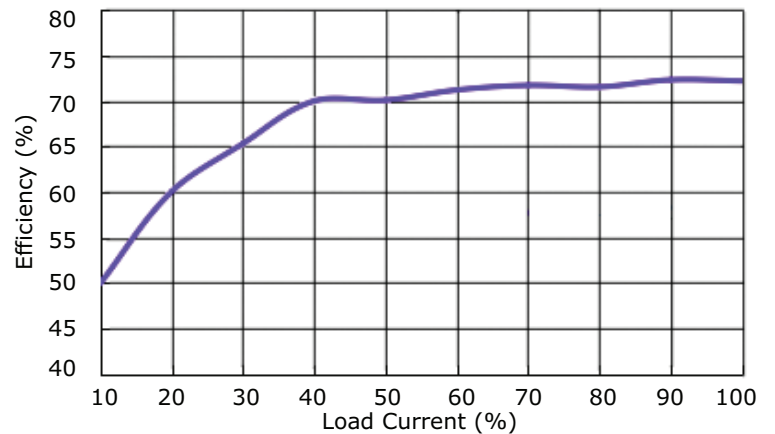

## APPLICATION CIRCUIT

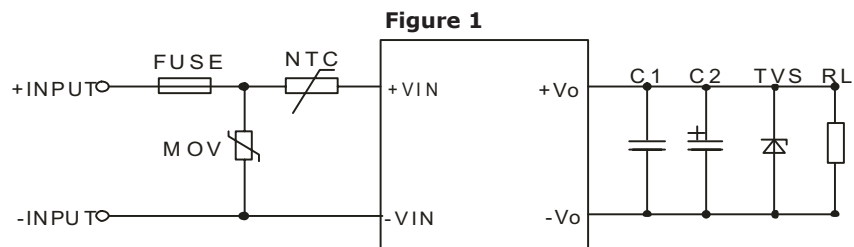

**Table 1**

Vout (Vdc)	Fuse	MOV	NTC	C1 (μF)	C2 (μF)	TVS
5	1 A / 1000 Vdc	S14K880	10D-11	1	220	SMBJ7.0A

## EMC RECOMMENDED CIRCUIT

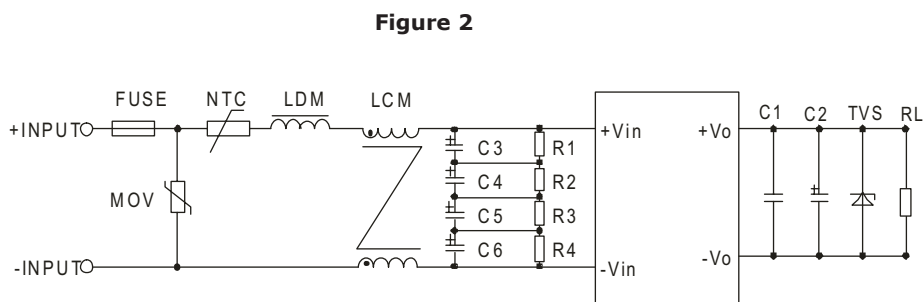

**Table 2**

Recommended External Circuit Components	
FUSE	1 A/1000 Vdc
MOV	S14K880
C3, C4, C5, C6	47 μF/400 Vdc
R1, R2, R3, R4	1 MΩ/2 W
NTC	10D-11
LDM	4.7 mH/0.38 A
LCM	10 mH

Note: See also Table 1.

Notes: 1. C1 is a ceramic capacitor used to filter high frequency noise.  
 2. C2 is electrolytic and is recommended to be high frequency and low resistance. For capacitance and current of the capacitor, refer to the datasheet provided by the manufacturer. Capacitance withstand voltage derating should be 80% or above.

## REVISION HISTORY

---

rev.	description	date
1.0	initial release	09/13/2017

The revision history provided is for informational purposes only and is believed to be accurate.



**Headquarters**  
20050 SW 112th Ave.  
Tualatin, OR 97062  
**800.275.4899**

Fax 503.612.2383  
**cui.com**  
techsupport@cui.com

CUI offers a two (2) year limited warranty. Complete warranty information is listed on our website.

CUI reserves the right to make changes to the product at any time without notice. Information provided by CUI is believed to be accurate and reliable. However, no responsibility is assumed by CUI for its use, nor for any infringements of patents or other rights of third parties which may result from its use.

CUI products are not authorized or warranted for use as critical components in equipment that requires an extremely high level of reliability. A critical component is any component of a life support device or system whose failure to perform can be reasonably expected to cause the failure of the life support device or system, or to affect its safety or effectiveness.