



SERIES: AE10-EW-T | DESCRIPTION: DC-DC CONVERTER

FEATURES

- 10 watts
- high operating temp -40 to +70°C
- 4,000 Vac isolation
- extra wide input voltage 10:1
- input voltage up to 1 kVdc
- OVP protection
- output short circuit protection
- chassis mounted
- EN 62109 approved



MODEL

MODEL	input voltage range (Vdc)	output voltage (Vdc)	output current		output power max (W)	ripple & noise ¹ max (mVp-p)	efficiency ² typ (%)
			min (A)	max (A)			
AE10-EW-S5-T	100~1000	5	0	2.00	10	200	72
AE10-EW-S9-T	100~1000	9	0	1.11	10	200	76
AE10-EW-S24-T	100~1000	24	0	0.42	10	200	80

Notes: 1. Measured at nominal input, 20 MHz bandwidth oscilloscope, with 10 μ F electrolytic and 1 μ F ceramic capacitors on the output.
 2. Measured at 200 Vdc input voltage, full load.
 3. All specifications are measured at $T_a=25^\circ\text{C}$, humidity < 75%, nominal input voltage, and rated output load unless otherwise specified.

PART NUMBER KEY

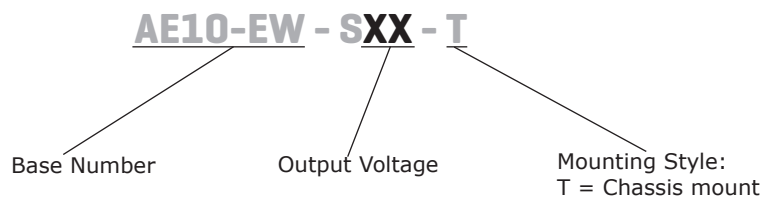

INPUT

parameter	conditions/description	min	typ	max	units
operating input voltage		100		1000	Vdc
current	at 200 Vdc			75	mA
	at 600 Vdc			25	mA
	at 1000 Vdc			16	mA
inrush current	at 200 Vdc		7		A
	at 600 Vdc		20		A
	at 1000 Vdc		30		A
input fuse	1 A / 1000 Vdc (external)				

OUTPUT

parameter	conditions/description	min	typ	max	units
maximum capacitive load	5 Vdc output model			6,000	μF
	9 Vdc output model			4,000	μF
	24 Vdc output model			470	μF
voltage accuracy			±1	±2	%
line regulation	from low line to high line, full load		±0.5	±1	%
load regulation	from 0% to full load		±0.5	±1	%
delay time	from Vin = 0 V to 90% of rated output voltage			1	s
switching frequency				75	kHz
temperature coefficient	at full load		±0.02		%/°C

PROTECTIONS

parameter	conditions/description	min	typ	max	units
over voltage protection	5 Vdc output model			7.5	Vdc
	9 Vdc output model			12	Vdc
	24 Vdc output model			28	Vdc
over current protection	automatic recovery	110			%
short circuit protection	continuous, automatic recovery				

SAFETY AND COMPLIANCE

parameter	conditions/description	min	typ	max	units
isolation voltage	input to output for 1 minute	4,000			Vac
safety approvals	EN 62109				
conducted emissions	CISPR22/EN55022, class A (external circuit required, see Figure 2)				
radiated emissions	CISPR22/EN55022, class A (external circuit required, see Figure 2)				
ESD	IEC/EN61000-4-2, contact ± 6kV/air ± 8kV, class B				
radiated immunity	IEC/EN61000-4-3, 10V/m, class A				
EFT/burst	IEC/EN61000-4-4, ± 4kV, class B (external circuit required, see Figure 2)				
surge	IEC/EN61000-4-5, ± 2kV, class B (external circuit required, see Figure 2)				
conducted immunity	IEC/EN61000-4-6, 10 Vr.m.s, class A				
MTBF	as per MIL-HDBK-217F, 25°C	300,000			hours
RoHS	2011/65/EU				

ENVIRONMENTAL

parameter	conditions/description	min	typ	max	units
operating temperature	see derating curves	-40		70	°C
storage temperature		-40		105	°C
storage humidity	non-condensing			95	%
altitude				2000	m

MECHANICAL

parameter	conditions/description	min	typ	max	units
dimensions	96.10 x 54.00 x 32.00 [3.783 x 2.126 x 1.260 inch]				mm
case material	black flame-retardant heat-proof plastic (UL94V-0)				
weight			150		g

MECHANICAL DRAWING

units: mm [inch]
tolerance: ±0.50[±0.020]

wire range: 24~12 AWG
tightening torque: max 0.4 N*m

PIN CONNECTIONS	
PIN	Function
1	-Vin
2	NC
3	+Vin
4	+Vout
5	NC
6	NC
7	-Vout

NC=no connection

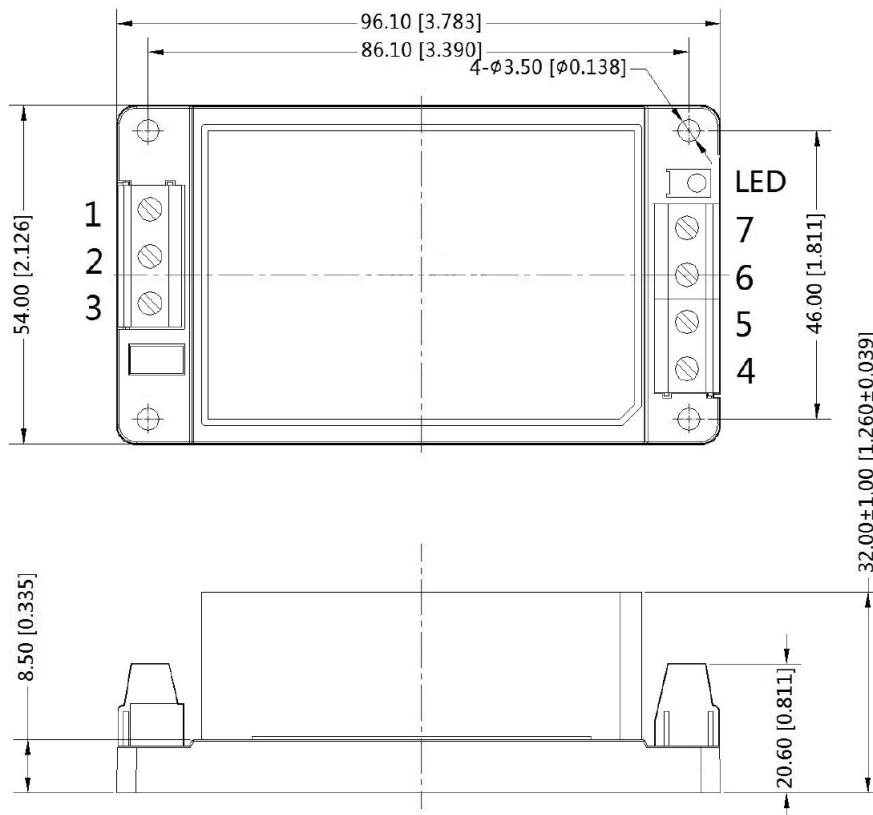

DERATING CURVES

Temperature Derating Curve
(100~150 Vdc input voltage)

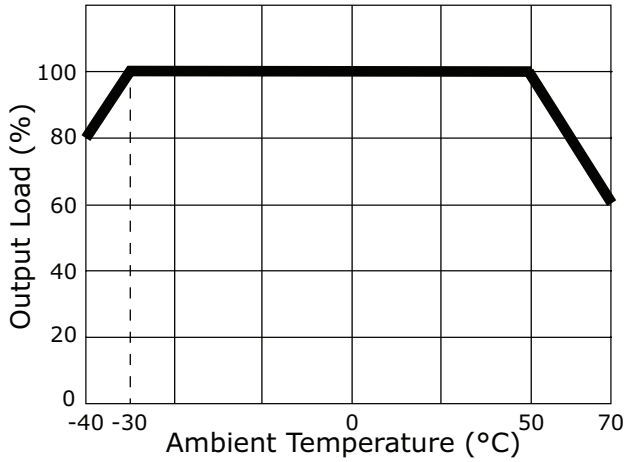

Temperature Derating Curve
(150~1000 Vdc input voltage)

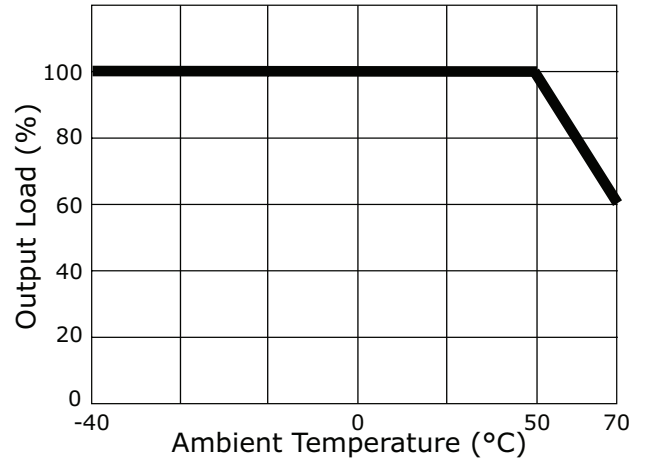

Load vs. Input Voltage Derating Curve
(at 25°C)

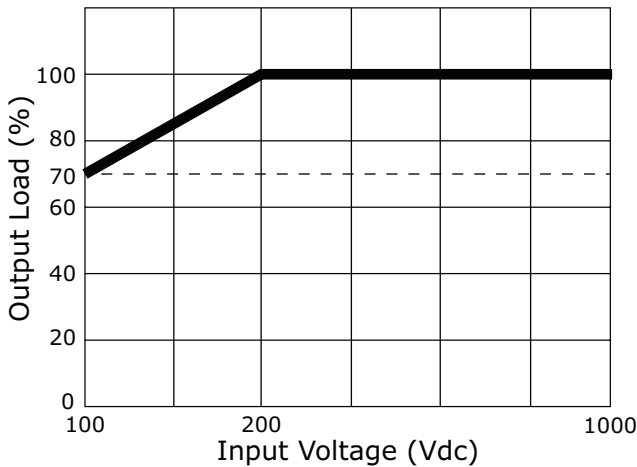

EFFICIENCY CURVES

AE10-EW-S5-T Efficiency Curve
Efficiency vs. Input Voltage

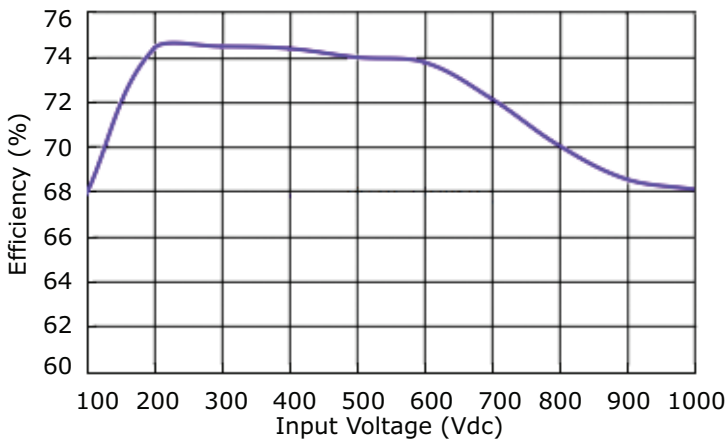

AE10-EW-S5-T Efficiency Curve
Efficiency vs. Load Current

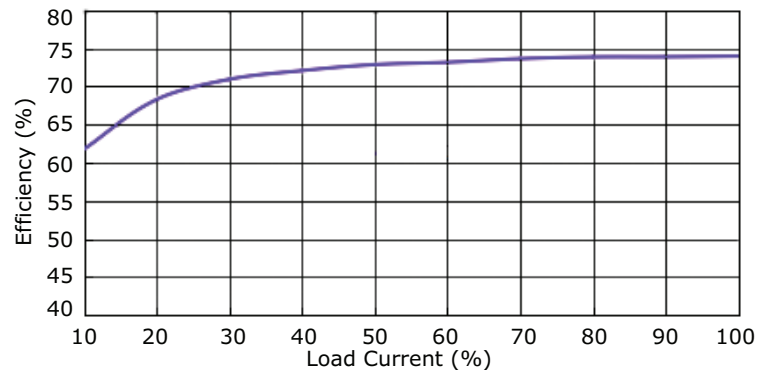

EFFICIENCY CURVES (CONTINUED)

AE10-EW-S9-T Efficiency Curve
Efficiency vs. Input Voltage

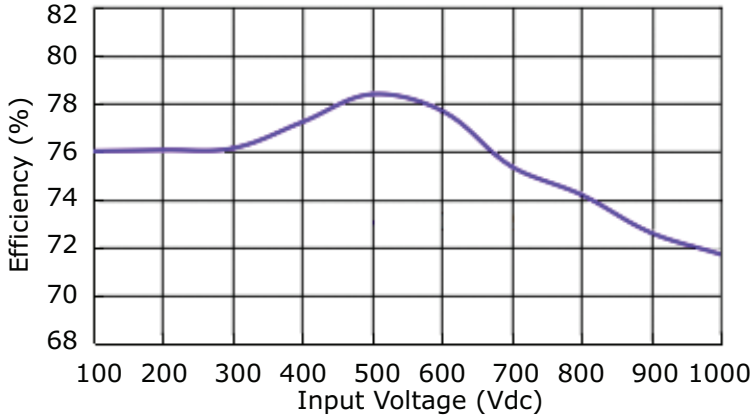

AE10-EW-S9-T Efficiency Curve
Efficiency vs. Load Current

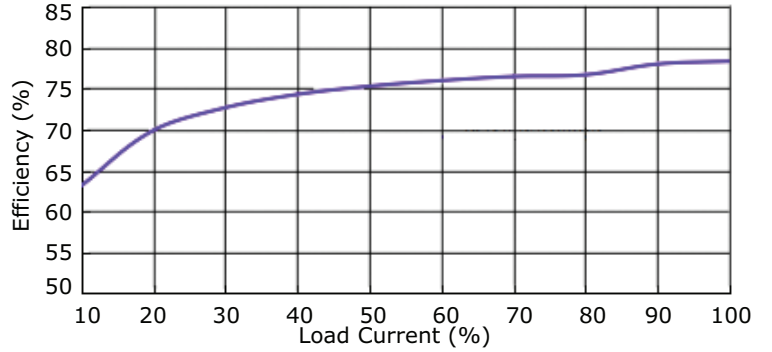

AE10-EW-S24-T Efficiency Curve
Efficiency vs. Input Voltage

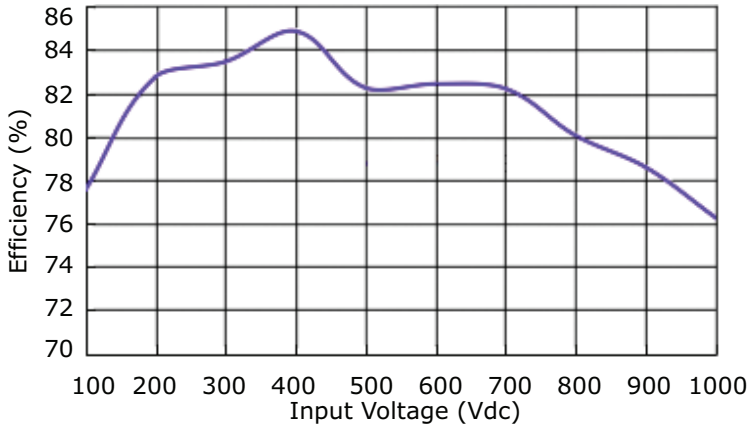

AE10-EW-S24-T Efficiency Curve
Efficiency vs. Load Current

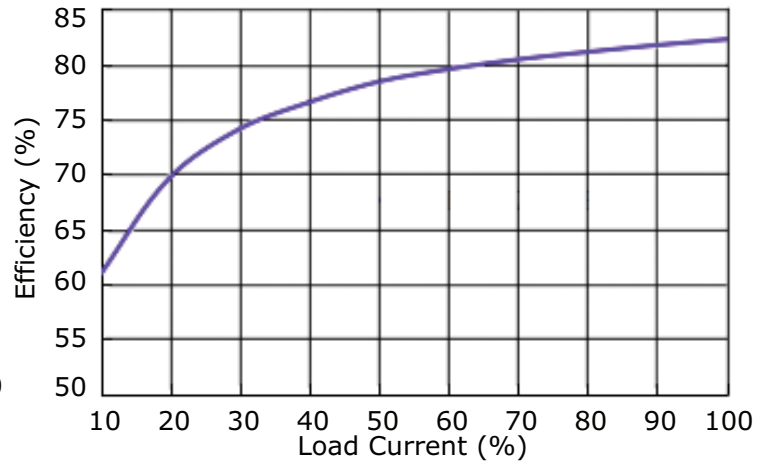

APPLICATION CIRCUIT

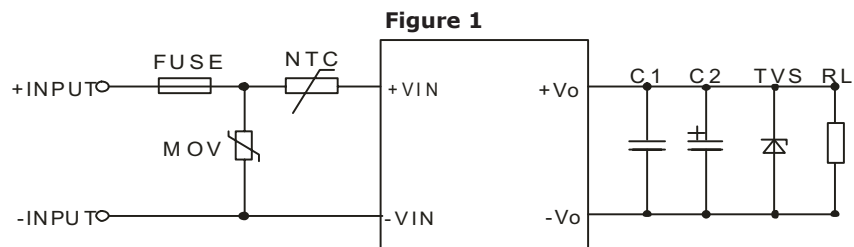

Table 1

Vout (Vdc)	Fuse	MOV	NTC	C1 (μF)	C2 (μF)	TVS
5	1 A / 1000 Vdc	S14K880	10D-11	1	220	SMBJ7.0A
9	1 A / 1000 Vdc	S14K880	10D-11	1	120	SMBJ12A
24	1 A / 1000 Vdc	S14K880	10D-11	1	68	SMBJ33A

EMC RECOMMENDED CIRCUIT

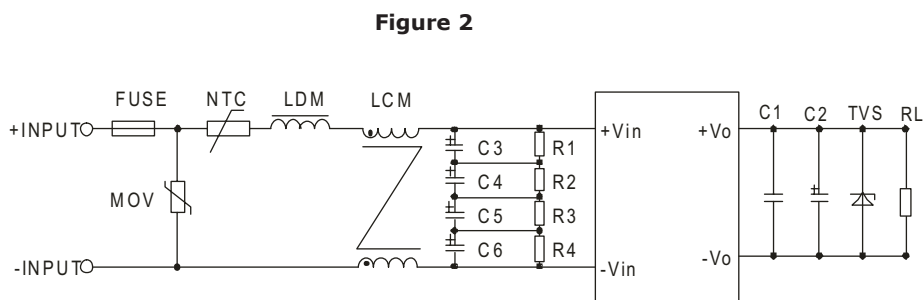

Table 2

Recommended External Circuit Components	
FUSE	1 A/1000 Vdc
MOV	S14K880
C3, C4, C5, C6	47 μF/400 Vdc
R1, R2, R3, R4	1 MΩ/2 W
NTC	10D-11
LDM	4.7 mH/0.38 A
LCM	10 mH

Note: See also Table 1.

- Notes:
1. C1 is a ceramic capacitor used to filter high frequency noise.
 2. C2 is electrolytic and is recommended to be high frequency and low resistance. For capacitance and current of the capacitor, refer to the datasheet provided by the manufacturer. Capacitance withstand voltage derating should be 80% or above.

REVISION HISTORY

rev.	description	date
1.0	initial release	09/13/2017

The revision history provided is for informational purposes only and is believed to be accurate.

**CUI INC**[®]**Headquarters**
20050 SW 112th Ave.
Tualatin, OR 97062
800.275.4899Fax 503.612.2383
cui.com
techsupport@cui.com

CUI offers a two (2) year limited warranty. Complete warranty information is listed on our website.

CUI reserves the right to make changes to the product at any time without notice. Information provided by CUI is believed to be accurate and reliable. However, no responsibility is assumed by CUI for its use, nor for any infringements of patents or other rights of third parties which may result from its use.

CUI products are not authorized or warranted for use as critical components in equipment that requires an extremely high level of reliability. A critical component is any component of a life support device or system whose failure to perform can be reasonably expected to cause the failure of the life support device or system, or to affect its safety or effectiveness.